



USER GUIDE

AgGPS® 432/442 GPS Receivers



USER GUIDE

AgGPS® 432 / 442 GPS Receivers

Version 3.30
Revision A
April 2008
Part Number 63198-00-ENG



Corporate Office

Trimble Navigation Limited
935 Stewart Drive
Sunnyvale, CA 94085
USA
www.trimble.com

Agriculture Business Area

Trimble Navigation Limited
10355 Westmoor Drive
Suite #100
Westminster, CO 80021
USA

www.trimble.com

Email: trimble_support@trimble.com

Legal Notices

© 2006–2008, Trimble Navigation Limited. All rights reserved.

Trimble, the Globe & Triangle logo, and AgGPS are trademarks of Trimble Navigation Limited, registered in the United States Patent and Trademark Office and in other countries. AutoBase, CMR, CMR+, Maxwell, Micro-Centered, SiteNet, TRIMMARK, VRS, Zephyr, and Zephyr Geodetic are trademarks of Trimble Navigation Limited.

The Bluetooth word mark and logos are owned by the Bluetooth SIG, Inc. and any use of such marks by Trimble Navigation Limited is under license.

Microsoft, Windows, and Windows NT are either registered trademarks or trademarks of Microsoft Corporation in the United States and/or other countries. All other trademarks are the property of their respective owners.

Release Notice

This is the April 2008 release (Revision A) of the *AgGPS 432 / 442 GPS Receiver User Guide*. It applies to version 3.30 of the receiver firmware.

Product Limited Warranty Information

For applicable product Limited Warranty information, please refer to the Limited Warranty Card included with this Trimble product, or consult your local Trimble authorized dealer.

Notices

Class B Statement – Notice to Users. This equipment has been tested and found to comply with the limits for a Class B digital device, pursuant to Part 15 of the FCC rules and Part 90. These limits are designed to provide reasonable protection against harmful interference in a residential installation. This equipment generates, uses, and can radiate radio frequency energy and, if not installed and used in accordance with the instructions, may cause harmful interference to radio communication. However, there is no guarantee that interference will not occur in a particular installation. If this equipment does cause harmful interference to radio or television reception, which can be determined by turning the equipment off and on, the user is encouraged to try to correct the interference by one or more of the following measures:

- Reorient or relocate the receiving antenna.

- Increase the separation between the equipment and the receiver.
- Connect the equipment into an outlet on a circuit different from that to which the receiver is connected.
- Consult the dealer or an experienced radio/TV technician for help.

Changes and modifications not expressly approved by the manufacturer or registrant of this equipment can void your authority to operate this equipment under Federal Communications Commission rules.

Canada

This Class B digital apparatus complies with Canadian ICES-003.

Cet appareil numérique de la classe B est conforme à la norme NMB-003 du Canada.

This apparatus complies with Canadian RSS-GEN, RSS-310, RSS-210, and RSS-119.

Cet appareil est conforme à la norme CNR-GEN, CNR-310, CNR-210, et CNR-119 du Canada.

Europe

This product (the AgGPS RTK Base GPS Receiver) is intended to be used in all EU member countries, Norway, and Switzerland.

This product has been tested and found to comply with the requirements for a Class B device pursuant to European Council Directive 89/336/EEC on EMC, thereby satisfying the requirements for CE Marking and sale within the European Economic Area (EEA). Contains Bluetooth radio module PBA 31308. These requirements are designed to provide reasonable protection against harmful interference when the equipment is operated in a residential or commercial environment. The 450 MHz (PMR) bands and 2.4 GHz are non-harmonized throughout Europe.



Australia and New Zealand

This product conforms with the regulatory requirements of the Australian Communications Authority (ACA) EMC framework, thus satisfying the requirements for C-Tick Marking and sale within Australia and New Zealand.



Taiwan – Battery Recycling Requirements

The product contains a removable Lithium-ion battery. Taiwanese regulations require that waste batteries are recycled.



廢電池請回收

Notice to Our European Union Customers

Directive 1999/5/EC

Hereby, Trimble Navigation, declares that the AgGPS RTK Base 450 and the AgGPS RTK Base 900 GPS receivers are in compliance with the essential requirements and other relevant provisions of Directive 1999/5/EC.

Restriction of Use of Certain Hazardous Substances in Electrical and Electronic Equipment (RoHS)

The following statement only applies to the AgGPS RTK Base GPS receiver (no internal radio and 450 MHz internal radio models only)

This Trimble product complies in all material respects with DIRECTIVE 2002/95/EC OF THE EUROPEAN PARLIAMENT AND OF THE COUNCIL of 27 January 2003 on the restriction of the use of certain hazardous substances in electrical and electronic equipment (RoHS Directive) and Amendment 2005/618/EC filed under C(2005) 3143, with exemptions for lead in solder pursuant to Paragraph 7 of the Annex to the RoHS Directive applied.

Declaration of Conformity

We, Trimble Navigation Limited,

935 Stewart Drive
PO Box 3642
Sunnyvale, CA 94088-3642
United States
+1-408-481-8000

declare under sole responsibility that the products:
AgGPS RTK Base 450 GPS receiver
AgGPS RTK Base 900 GPS receiver
comply with Part 15 of FCC Rules.

Operation is subject to the following two conditions:
(1) this device may not cause harmful interference, and
(2) this device must accept any interference received, including interference that may cause undesired operation.

Waste Electrical and Electronic Equipment (WEEE)

For product recycling instructions and more information, please go to www.trimble.com/ev.shtml.

Recycling in Europe: To recycle Trimble WEEE (Waste Electrical and Electronic Equipment, products that run on electrical power.), Call +31 497 53 24 30, and ask for the "WEEE Associate". Or, mail a request for recycling instructions to:
Trimble Europe BV
c/o Menlo Worldwide Logistics
Meerheide 45
5521 DZ Eersel, NL



Safety Information

Before you use your Trimble® RTK Base GPS receiver, make sure that you have read and understood all safety requirements.

Regulations and safety

The receivers contain an internal radio-modem and can send signals through Bluetooth® wireless technology or through an external data communications radio. Regulations regarding the use of the 450 MHz radio-modems vary greatly from country to country. In some countries, the unit can be used without obtaining an end-user license. Other countries require end-user licensing. For licensing information, consult your local Trimble dealer. Bluetooth, 900 MHz, and 2.4 GHz radio-modems operate in license-free bands.

Before operating an AgGPS RTK Base GPS receiver, determine if authorization or a license to operate the unit is required in your country. It is the responsibility of the end user to obtain an operator's permit or license for the receiver for the location or country of use.

For FCC regulations, see [Notices, page 2](#).

Type approval

Type approval, or acceptance, covers technical parameters of the equipment related to emissions that can cause interference. Type approval is granted to the manufacturer of the transmission equipment, independent from the operation or licensing of the units. Some countries have unique technical requirements for operation in particular radio-modem frequency bands. To comply with those requirements, Trimble may have modified your equipment to be granted Type approval. Unauthorized modification of the units voids the Type approval, the warranty, and the operational license of the equipment.

Exposure to radio frequency radiation

For 450 MHz radio

Safety. Exposure to RF energy is an important safety consideration. The FCC has adopted a safety standard for human exposure to radio frequency electromagnetic energy emitted by FCC regulated equipment as a result of its actions in General Docket 79-144 on March 13, 1986.

Proper use of this radio modem results in exposure below government limits. The following precautions are recommended:

- **DO NOT** operate the transmitter when someone is within 20 cm (7.8 inches) of the antenna.
- **DO NOT** operate the transmitter unless all RF connectors are secure and any open connectors are properly terminated.
- **DO NOT** operate the equipment near electrical blasting caps or in an explosive atmosphere.
- All equipment must be properly grounded according to Trimble installation instructions for safe operation.
- All equipment should be serviced only by a qualified technician.

For license-free 900 MHz radio¹



CAUTION – For your own safety, and in terms of the RF Exposure requirements of the FCC, always observe the precautions listed here.

- Always maintain a minimum separation distance of 20 cm (7.8 inches) between yourself and the radiating antenna on the radio-modem.
- Do not co-locate the antenna with any other transmitting device.

¹ 900 MHz radios are not used in Europe.

For Bluetooth radio

The radiated output power of the internal Bluetooth wireless radio is far below the FCC radio frequency exposure limits. Nevertheless, the wireless radio shall be used in such a manner that the Trimble receiver is 20 cm or further from the human body. The internal wireless radio operates within guidelines found in radio frequency safety standards and recommendations, which reflect the consensus of the scientific community. Trimble therefore believes the internal wireless radio is safe for use by consumers. The level of energy emitted is far less than the electromagnetic energy emitted by wireless devices such as mobile phones. However, the use of wireless radios may be restricted in some situations or environments, such as on aircraft. If you are unsure of restrictions, you are encouraged to ask for authorization before turning on the wireless radio.

Installing antennas



CAUTION – For your own safety, and in terms of the RF Exposure requirements of the FCC, always observe these precautions:

- Always maintain a minimum separation distance of 20 cm (7.8 inches) between yourself and the radiating antenna.
 - Do not co-locate the antenna with any other transmitting device.
-

This device has been designed to operate with the antennas listed below, and having a maximum gain of 5 dBi. Antennas not included in this list, or having a gain greater than 5 dBi, are strictly prohibited for use with this device. The required antenna impedance is 50 ohms.

The antennas that can be used (country dependent) with the 450 MHz radio are 0 dBi and 5 dBi whip antennas. The antennas that can be used (country dependent) with the 900 MHz radio are 0 dBi, 3 dBi, and 5 dBi whip antennas.

To reduce potential radio interference to other users, the antenna type and its gain should be so chosen that the equivalent isotropically radiated power (e.i.r.p.) is not more than that permitted for successful communication.

Battery safety



WARNING – Do not damage the rechargeable Lithium-ion battery. A damaged battery can cause an explosion or fire, and can result in personal injury and/or property damage.

To prevent injury or damage:

- Do not use or charge the battery if it appears to be damaged. Signs of damage include, but are not limited to, discoloration, warping, and leaking battery fluid.
 - Do not expose the battery to fire, high temperature, or direct sunlight.
 - Do not immerse the battery in water.
 - Do not use or store the battery inside a vehicle during hot weather.
 - Do not drop or puncture the battery.
 - Do not open the battery or short-circuit its contacts.
-



WARNING – Avoid contact with the rechargeable Lithium-ion battery if it appears to be leaking. Battery fluid is corrosive, and contact with it can result in personal injury and/or property damage.

To prevent injury or damage:

- If the battery leaks, avoid contact with the battery fluid.
 - If battery fluid gets into your eyes, immediately rinse your eyes with clean water and seek medical attention. Do not rub your eyes!
 - If battery fluid gets onto your skin or clothing, immediately use clean water to wash off the battery fluid.
-



WARNING – Charge and use the rechargeable Lithium-ion battery only in strict accordance with the instructions. Charging or using the battery in unauthorized equipment can cause an explosion or fire, and can result in personal injury and/or equipment damage.

To prevent injury or damage:

- Do not charge or use the battery if it appears to be damaged or leaking.
 - Charge the Lithium-ion battery only in a Trimble product that is specified to charge it. Be sure to follow all instructions that are provided with the battery charger.
 - Discontinue charging a battery that gives off extreme heat or a burning odor.
 - Use the battery only in Trimble equipment that is specified to use it.
 - Use the battery only for its intended use and according to the instructions in the product documentation.
-

Contents

Safety Information	5
Regulations and safety	5
Type approval	5
Exposure to radio frequency radiation	6
For 450 MHz radio	6
For license-free 900 MHz radio	6
For Bluetooth radio	7
Installing antennas	7
Battery safety.	8
1 Introduction	13
About the AgGPS 432/442 receivers	14
AgGPS 432 GPS receiver	14
AgGPS 442 GNSS GPS receiver	14
Related information	14
Technical support.	14
Your comments	15
2 Features and Functions	17
AgGPS 432 receiver features	18
AgGPS 442 GNSS receiver features	18
Use and care	19
COCOM limits	20
Keypad and display.	20
Rear connectors	21

3	Batteries and Power23
	External power	24
	Battery safety.	24
	Battery performance	25
	Charging the Lithium-ion battery.	26
	Storing the Lithium-ion battery	27
	Removing the Lithium-ion battery	27
4	Setup Guidelines29
	Base station operation guidelines.	30
	Base station components.	30
	Base station setup guidelines	31
	Permanent installation antenna cabling for the AgGPS 442 GPS receiver	34
	Rover operation guidelines	35
	Rover receiver components	35
	Rover receiver setup guidelines	35
5	Setting up the Receiver39
	Common ways to set up a base station	40
	Setting up a base station for permanent installation.	40
	Setting up a mobile base station: Tripod and fixed height tripod	41
	Tripod and tribrach setup	41
	Fixed height tripod setup.	42
	External radio-modems.	42
6	Configuring the Receiver Using the Keypad and Display45
	Button functions	46
	Power button operations	47
	Home screen	48
	Status screens	48
	Configuring the receiver as a base receiver	49
	Configuring the receiver	49
	Configuring the AgGPS 432/442 as a rover receiver.	53
	Configuring the receiver	53
	Changing the elevation mask and RTK mode	53

Selecting the antenna	54
Outputting corrections	54
Configuring system settings	55
Configuring Ethernet settings	56
Configuring the AgGPS 432/442 receiver using a web browser	60
Supported browsers	60
Connecting to the receiver using a web browser	61
Changing the settings	62
Receiver Status menu	64
Satellites menu	65
Receiver Configuration menu	66
I/O Configuration menu	67
Radio menu	68
OmniSTAR menu	70
Internet Configuration menu	71
Security menu	72

7 Automatically Setting up a Mobile Base Station Using AutoBase Technology73

AutoBase Warning	74
Working with AutoBase technology	74
Scenario One: First visit to a site with AutoBase Warning turned off . .	74
Scenario Two: First visit to a site with AutoBase Warning turned on . .	76
Scenario Three: Repeat visit to a site with AutoBase Warning turned off	76
Scenario Four: Repeat visit to a site with AutoBase Warning turned on	77
The AutoBase process	79

8 Default Settings81

Default receiver settings	82
Resetting the receiver to factory defaults	82

9	Specifications83
	General specifications	84
	Physical specifications	84
	Electrical specifications	85
	Communication specifications	86
A	Required Radio and GPS Rover Firmware87
	Radio firmware	88
	GPS rover firmware	89
B	Upgrading the Receiver Firmware91
	The WinFlash utility	92
	Installing the WinFlash utility	92
	Upgrading the receiver firmware	93
	Forcing the receiver into Monitor mode	94
C	Troubleshooting.95
	Receiver issues.	96
D	Drawings.99
	Back view100
	Side view100
	Bottom view101
E	Receiver Connector Pinout Information	103
	Lemo connector.104
	Modem multi-function port105
	Glossary	107

Introduction

In this chapter:

- [About the AgGPS 432/442 receivers](#)
- [Related information](#)
- [Technical support](#)
- [Your comments](#)

Welcome to the *AgGPS 432 / 442 GPS Receiver User Guide*. This manual describes how to set up and use the AgGPS® 432 / 442 GPS receivers from Trimble.

Even if you have used other Global Positioning System (GPS) products before, Trimble recommends that you spend some time reading this manual to learn about the special features of this product. If you are not familiar with GPS, visit the Trimble website (www.trimble.com) for an interactive look at Trimble and GPS.

About the AgGPS 432/442 receivers

AgGPS 432 GPS receiver

The Trimble® AgGPS 432 GPS receiver is a dual-frequency location GPS receiver and is designed as a rugged RTK rover receiver that can be configured using the keypad and display or a web browser. It is an ideal mobile receiver for use in agricultural vehicles.

The AgGPS 432 receiver is designed to work with the Trimble Autopilot system.

AgGPS 442 GNSS GPS receiver

The AgGPS 442 GNSS receiver is a triple-frequency GPS with GLONASS receiver. The receiver can operate as a base or rover receiver, and can be configured using either the keypad and display or a web browser. It can easily be set up as a mobile or fixed base station, and is also an ideal receiver for mounting in a vehicle.

Related information

Trimble training courses – Consider a training course to help you use your GPS system to its fullest potential. For more information, go to the Trimble website at www.trimble.com/training.html.

Technical support

If you have a problem and cannot find the information you need in the product documentation, contact your local dealer. Alternatively, go to the Support area of the Trimble website (www.trimble.com/support.shtml). Select the product you need information on. Product updates, documentation, and any support issues are available for download.

If you need to contact Trimble technical support, complete the online inquiry form at www.trimble.com/support_form.asp.

Your comments

Your feedback about the supporting documentation helps us to improve it with each revision. Email your comments to ReaderFeedback@trimble.com.

Features and Functions

In this chapter:

- [AgGPS 432 receiver features](#)
- [AgGPS 442 GNSS receiver features](#)
- [Use and care](#)
- [COCOM limits](#)
- [Keypad and display](#)
- [Rear connectors](#)

The Trimble *AgGPS* 432/442 GPS receivers are fully featured receivers that can be used in a range of agricultural applications. Both the *AgGPS* 432 and 442 receiver can be configured for use in a vehicle as an RTK rover. The *AgGPS* 442 receiver can also be configured as either a mobile or fixed RTK base station. The receivers feature a keypad and display so that you can configure the receiver without using an external computer.

AgGPS 432 receiver features

The AgGPS 432 receiver has the following features:

- Integrated GPS receiver and radio
- 450 or 900 MHz receive radio
- 24 channel L1/L2 GPS receiver
- WAAS/EGNOS and MSAS Satellite Based Augmentation compatibility
- Long-life integrated battery, typically 12 hours as a rover
- Operation parameters are configured using the WinFlash utility, the integrated keypad and display, or the Web receiver interface
- Small, lightweight design. The receiver (with battery) weighs 1.65 kg (3.64 lbs) only.
- Easy to use menu system for rapid configuration and status checking
- Ethernet support, so that the receiver can be configured remotely across an Ethernet network or the Internet
- Two-line, 16 character VFD (Vacuum Fluorescent Display)
- CAN (Controller Area Network) support
- Rugged, weatherproof construction with an IP67 rating
- -40 °C to +65 °C (-40 °F to +149 °F) operating temperature range
- 9 V to 30 V DC input power with over-voltage protection

AgGPS 442 GNSS receiver features

The receiver provides the following features:

- Integrated GPS receiver and radio
- 450 MHz or 900 MHz transmit/receive radio
- 72-channel L1/L2/L2C/L5 GPS plus L1/L2 GLONASS receiver

- WAAS/EGNOS and MSAS Satellite Based Augmentation compatibility
- Long-life integrated battery, typically 12 hours as a rover or 10 hours as a base station
- Operation parameters configured using the WinFlash utility, the integrated keypad and display, or the Web receiver interface
- Small, lightweight design. The receiver (with battery) weighs 1.65 kg (3.64 lb) only.
- Easy to use menu system for rapid configuration and status checking
- AutoBase™ technology for rapid and automated repeated daily base station configuration
- Ethernet support, so that the receiver can be configured remotely across an Ethernet network or the Internet
- Two-line, 16 character VFD (Vacuum Fluorescent Display)
- CAN (Controller Area Network) support
- Rugged, weatherproof construction with an IP67 rating
- -40 °C to +65 °C (-40 °F to +149 °F) operating temperature range
- 9 V to 30 V DC input power range, with over-voltage protection

Use and care

This product is designed to withstand the rough treatment and tough environment that typically occurs in construction applications. However, the receiver is a high-precision electronic instrument and should be treated with reasonable care.



CAUTION – Operating or storing the receiver outside the specified temperature range can damage it. For more information, see [Chapter 9, Specifications](#).

COCOM limits

The U.S. Department of Commerce requires that all exportable GPS products contain performance limitations so that they cannot be used in a manner that could threaten the security of the United States. The following limitations are implemented on this product:

- Immediate access to satellite measurements and navigation results is disabled when the receiver velocity is computed to be greater than 1,000 knots, or its altitude is computed to be above 18,000 meters. The receiver GPS subsystem resets until the COCOM situation clears. As a result, all logging and stream configurations stop until the GPS subsystem is cleared.

Keypad and display

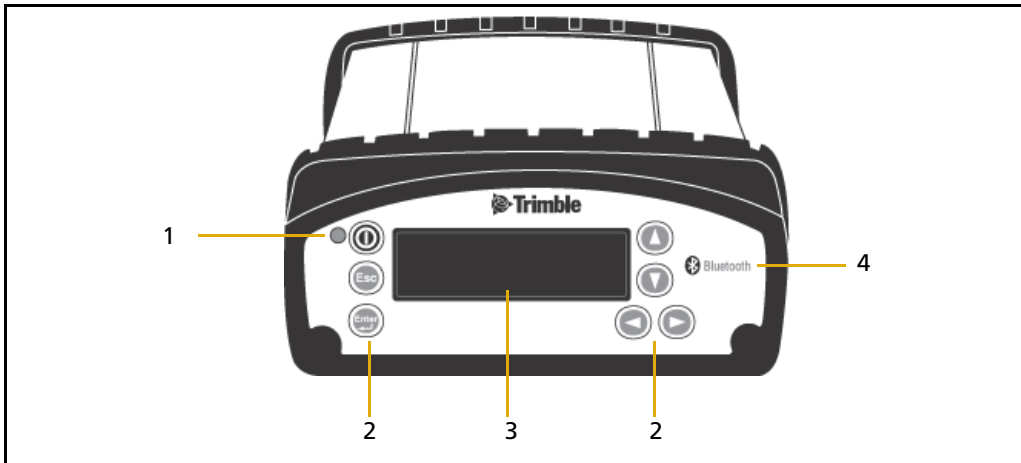

Figure 2.1 Front view of the receiver

Feature	Description
1 Power LED	Indicates if the receiver is turned on or off.
2 Buttons	Used to turn on and configure the receiver (see Button functions, page 46).

Feature	Description
3 Display	The receiver has a Vacuum Fluorescent Display. This display allows you to see how the receiver is operating and view the configuration settings.
4 Bluetooth antenna	Location of the Bluetooth antenna.

Rear connectors

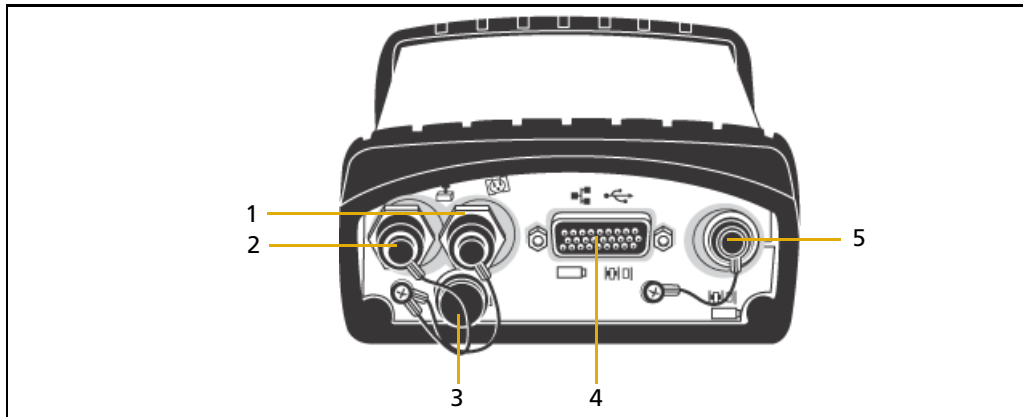



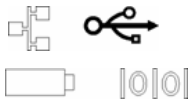



Figure 2.2 Rear view of the receiver

Connector type	Description
1 TNC 	Connect to the GPS antenna
2 <ul style="list-style-type: none"> • TNC (450 MHz Internal radio) • Reverse polarity TNC (900 MHz internal radio) • Not installed, system without internal radio 	Connect to the radio antenna
3 Vent plug  VENT: DO NOT REMOVE	External venting plug for pressure equalization

	Connector type	Description
4	High Density DB26 	<ul style="list-style-type: none"> • Ethernet connectivity to a 10/100 Base-T network through an RJ45 jack on a multiport adaptor (P/N 57167) • 'Slave' USB communications through the USB type B connector on the multiport adaptor (P/N 57167) • 'Host' USB communications through the USB type A connector on the 26-pin to Hirose adaptor (P/N 56653-10) and Hirose to USB type A cable (P/N 73841001) • Primary power from a Trimble AC/DC power supply (P/N 59221-00) using the multiport adaptor (P/N 57167) • Power input from an SPS700 total station battery cradle system using the adaptor (P/N 56653-10) • Full 9-wire RS-232 serial communications using the 26-9-pin multiport adaptor (P/N 57168) or a 26-pin serial communications cable • 1PPS, 2 x RS-232 input DC, USB, Ethernet cable (P/N 60789-00)
5	Lemo (7-pin/0-shell) 	<ul style="list-style-type: none"> • 3 wire RS-232 serial communications using a 7-pin/ 0 shell Lemo cable • Secondary power from a Trimble battery (P/N 32364-00 or 32365-00) or a 12 V battery using the Fused Lemo Power Cable (P/N 46125-20) • CAN

Batteries and Power

In this chapter:

- External power
- Battery safety
- Battery performance
- Charging the Lithium-ion battery
- Storing the Lithium-ion battery
- Removing the Lithium-ion battery

The AgGPS RTK Base GPS receiver uses an internal rechargeable Lithium-ion battery, which can be replaced only at an Authorized Trimble Service Center.

The receiver can also be powered by an external power source that is connected to the Lemo or modem port.

The operational time provided by the internal battery depends on the type of measurement and operating conditions. Typically, the internal battery provides 10 hours operation as a base station.

***Note** – All battery operation tests are carried out with new, fully charged batteries at room temperature and full receiver configuration operational. Older batteries, at temperatures significantly higher or lower than room temperature, will have a reduced performance.*

External power

The GPS receiver uses an external power source in preference to its internal batteries. If the receiver is not connected to an external power source, or if the external power supply fails, the internal batteries are used.

Battery safety

The receiver is powered by a rechargeable internal Lithium-ion battery. Charge and use the battery only in strict accordance with the instructions below.



WARNING – Do not damage the rechargeable Lithium-ion battery. A damaged battery can cause an explosion or fire, and can result in personal injury and/or property damage.

To prevent injury or damage:

- Do not use or charge the battery if it appears to be damaged. Signs of damage include, but are not limited to, discoloration, warping, and leaking battery fluid.
 - Do not expose the battery to fire, high temperature, or direct sunlight.
 - Do not immerse the battery in water.
 - Do not use or store the battery inside a vehicle during hot weather.
 - Do not drop or puncture the battery.
 - Do not open the battery or short-circuit its contacts.
-



WARNING – Avoid contact with the rechargeable Lithium-ion battery if it appears to be leaking. Battery fluid is corrosive, and contact with it can result in personal injury and/or property damage.

To prevent injury or damage:

- If the battery leaks, avoid contact with the battery fluid.
 - If battery fluid gets into your eyes, immediately rinse your eyes with clean water and seek medical attention. Do not rub your eyes!
 - If battery fluid gets onto your skin or clothing, immediately use clean water to wash off the battery fluid.
-

Battery performance

To optimize battery performance and extend battery life:

- Fully charge all new batteries before use.
- Batteries perform best when they are not used at extreme temperatures. The receiver is designed to operate at -40°C to $+65^{\circ}\text{C}$ (-40°F to $+149^{\circ}\text{F}$). However, operation at temperatures of less than 0°C (32°F) can cause a rapid drop in battery life.
- Do not allow a battery that is in storage to discharge to below 5 V.

Charging the Lithium-ion battery

The rechargeable Lithium-ion battery is supplied partially charged. Charge the battery completely before using it for the first time. If the battery has been stored for longer than three months, charge it before use.

The internal battery charges fully in 8 hours when connected to a suitable power source.



WARNING – Charge and use the rechargeable Lithium-ion battery only in strict accordance with the instructions. Charging or using the battery in unauthorized equipment can cause an explosion or fire, and can result in personal injury and/or equipment damage.

To prevent injury or damage:

- Do not charge or use the battery if it appears to be damaged or leaking.
 - Charge the Lithium-ion battery only with a Trimble product that is specified to charge it. Be sure to follow all instructions that are provided with the battery charger.
 - Discontinue charging a battery that gives off extreme heat or a burning odor.
 - Use the battery only in Trimble equipment that is specified to use it.
 - Use the battery only for its intended use and according to the instructions in the product documentation.
-

Storing the Lithium-ion battery

If you must store a Lithium-ion battery for long periods, make sure that it is fully charged before it is stored, and that you charge it at least once every three months while it is stored.

Do not allow a battery that is in storage to discharge to below 5 V. A battery that reaches deep discharge level (5 V or less) cannot be recharged and must be replaced. (To protect a battery that is in use from deep discharge, the receiver switches power sources or stops drawing power when the battery pack discharges to 5.9 V.)

All batteries discharge over time when not in use, and they discharge faster in colder temperatures. Do not store the receiver at temperatures outside the range -40°C to $+70^{\circ}\text{C}$ (-40°F to $+158^{\circ}\text{F}$).

The receiver has an internal Lithium-ion battery. The internal battery will only charge from an external power source that delivers more than 15 volts, for example, an AC power adaptor. The receiver is supplied with a mains power supply unit that recharges the battery inside the receiver when it is connected through the adaptor to the modem port or the Lemo port. When you use the receiver as a fixed or permanent base station, Trimble recommends that you use this power supply at all times to keep the internal battery charged. This provides an uninterrupted power supply and will keep the site operational for more than 10 hours after a power failure.

Keep all batteries on continuous charge when not in use. You can keep batteries on charge indefinitely without damage to the receiver or to the batteries.

Removing the Lithium-ion battery

The internal Lithium-ion battery should be removed only at an authorized Trimble Service Center. If the battery is removed at an unauthorized service center, the remaining warranty on the product will be void.

Setup Guidelines

In this chapter:

- [Base station operation guidelines](#)
- [Rover operation guidelines](#)

GPS Real-Time Kinematic (RTK) operation provides centimeter-level accuracy by eliminating errors that are present in the GPS system. For all RTK operations, you require both a base station and a rover receiver.

This chapter introduces the concepts of base station and rover operation, provides information to help you identify good setup locations, describes best practices for setting up the equipment, and outlines the precautions that you need to take to protect the equipment.

Base station operation guidelines

A base station consists of a receiver that is placed at a known (and fixed) position. The receiver tracks the same satellites that are being tracked by the rover receiver, at the same time that the rover is tracking them. Errors in the GPS system are monitored at the fixed (and known) base station, and a series of position corrections are computed. The corrections are sent through a radio link to the rover receiver, where they are used to correct the real time positions of the rover.

Base station components

The base station has the following components:

- GPS receiver
- GPS antenna
- Base station radio
- Power supply

GPS receiver and GPS antenna

A GPS receiver, such as the *AgGPS* 442 receiver, incorporates a GPS receiver, power supply, and base station radio in a single unit. The GPS antenna and the base station radio antenna are separate from the receiver. Because the GPS antenna is separate, you can use the following optimized components:

- a geodetic antenna with large ground plane, to eliminate multipath (the major source of GPS errors) at the base station
- a high-gain or directional radio antenna, to increase broadcast range and to provide maximum coverage

You can also place the GPS receiver in an easily accessible and secure location, safe from theft and the weather, while the antennas are placed high on a tower or building, clear of obstructions, and able to deliver maximum performance.

The GPS antenna included with the AgGPS 432 or 442 receiver is a Trimble Zephyr Geodetic™ Model 2 antenna. The Zephyr Geodetic Model 2 antenna has a large ground plane to eliminate multipath and can be used in both fixed (permanent) installations and mobile base station applications.

Base station setup guidelines

For good performance, observe the following base station setup guidelines:

- Place the GPS antenna in a location that has a clear line of sight to the sky in all directions. Do not place the GPS antenna near vertical obstructions such as buildings, deep cuttings, fences, towers, or tree canopy.
- Mount the GPS antenna securely to minimize movement of the antenna. Any movement of the base station GPS antenna will cause corresponding movement in the rover.
- Place the GPS and radio antennas as high as practical. Radio antenna height is a significant factor in the broadcast range of the radio.

Note – *The GPS antenna must have a clear line of sight to the sky at all times during operation.*

- Choose the most appropriate radio antenna for the desired coverage area. The higher the gain on the antenna, the longer the range. If there is more focus on the transmission signal, there is a reduced coverage area. A 3 dB or 5 dB gain antenna provides a mix of good range and reasonable directional coverage.

- Make sure that the GPS receiver does not lose power. The GPS receiver has an integrated battery, which has to be charged. To operate for the full day without loss of power at the base station, provide external power. Sources of external power include:
 - AC power
 - 12 V car or truck battery
 - Generator power
 - Solar panel

When you use an external power supply, the integrated battery provides a backup power supply, enabling you to maintain continuous operation through a mains power failure.

When the GPS receiver is connected to a power source greater than 15 V, the integrated battery is continuously charged from the connected power source. This helps to ensure that the battery stays charged.

- Do not locate a GPS receiver, GPS antenna, or radio antenna within 400 meters (about 1,300 feet) of:
 - a powerful radar, television, or cellular communications tower
 - another transmitter
 - another GPS antenna

Cell phone towers can interfere with the base station radio broadcast and can stop corrections from reaching the rover receiver. High-power signals from a nearby radio or radar transmitter can overwhelm the receiver circuits. This does not harm the receiver, but can prevent the receiver electronics from functioning correctly.

Low-power transmitters, such as those in cell phones and two-way radios, do not interfere with receiver operations.

- Do not set up the base station directly beneath or close to overhead power lines or electrical generation facilities. The electromagnetic fields associated with these utilities can interfere with GPS receiver operation. Other sources of electromagnetic interference include:
 - Gasoline engines (spark plugs)
 - Televisions and computer monitors
 - Alternators and generators
 - Electric motors
 - Equipment with DC-to-AC converters
 - Fluorescent lights
 - Switching power supplies
- Place the GPS receiver in a protected and secure location.
- If you place the *AgGPS* 442 receiver in a lock box or other enclosure to protect the receiver from theft or from the weather, shield the lock box from direct sunlight and provide ventilation for the receiver through an inlet and extractor fan. A receiver that has a broadcast radio generates significant heat. Do not allow the temperature in the box to exceed 50 °C (122 °F).
- If working in a cold climate, you may need to provide heat to the receiver. Do not operate the receiver below –40 °C (–40 °F).
- Trimble recommends that, wherever possible, you keep GPS receiver equipment dry. The receivers are designed to withstand wet weather, but keeping them dry prolongs their life and reduces the effects of corrosion on ports and connectors. If the equipment gets wet, use a clean dry cloth to dry the equipment and then leave the equipment open to the air to dry. Do not lock wet equipment in a transport case for prolonged periods. Avoid exposing the GPS receiver to corrosive liquids and salt water wherever possible.

- Trimble recommends that you install lightning protection equipment at permanent base station locations. Equipment should include a gas capsule lightning protector in the GPS and radio antenna feed line and appropriate safety grounding. A static dissipater near the antennas can reduce the likelihood of a direct lightning strike. Also protect any communications and power lines at building entry points. For more information, contact your local Trimble dealer, or go to the Huber and Suhner website (www.hubersuhnerinc.com).
- Trimble recommends that you use surge protection equipment on all permanently installed equipment.

Permanent installation antenna cabling for the AgGPS 442 GPS receiver

Many permanent base station installations have unique cabling requirements. Depending on the available infrastructure, you may need to mount the antenna a considerable distance from the receiver.

The AgGPS 442 receiver can withstand a loss of 12 dB between the GPS antenna and the receiver. The degree of loss in a coaxial cable depends on the frequency of the signal passing through it. This table lists some common cable types and the maximum length you can use before an inline amplifier for GPS frequencies is required.

Cable type	Maximum length (for use without an inline amplifier)
RG-214	30 m (100 ft)
LMR-400	70 m (230 ft)
LMR-500	85 m (280 ft)
LMR-600	106 m (350 ft)
Heliac LDF4/50	165 m (540 ft)
Heliac LDF4.5/40	225 m (740 ft)

Rover operation guidelines

The second part of the RTK GPS system is the rover receiver.

The rover receiver is mounted in a vehicle and is receiving corrections from an RTK base station. The connection is provided by the integrated radio or other communications device connected to the receiver.

The correction stream for some other positioning solutions, such as SBAS (WAAS/EGNOS/MSAS), is broadcast through geostationary satellites, and detected by the GPS antenna itself. No integrated radio or base is required.

Rover receiver components

The rover receiver has the following components:

- GPS receiver
- GPS antenna
- Radio antenna

In most rover applications the receiver operates from the power supplied from the vehicle. In some instances, the rover can be operated using only the integrated battery unit. Use external power if it is available, the internal battery then acts as an uninterruptable power supply.

Rover receiver setup guidelines

For good rover operation, observe the following setup guidelines:

- Place the GPS antenna in a location that has a clear line of sight to the sky in all directions. Do not place the antenna near vertical obstructions. GPS rovers and base station receive the same satellite signals from the same satellites: if you obscure the signals at times, the system will be unable to provide RTK Fixed positions.
- Place the GPS and radio antennas as high as possible to minimize multipath from the surrounding area. The receiver must have a clear line of sight to the sky at all times during operation.

- GPS satellites are constantly moving. Because you cannot measure at a specific location does not mean that you will not be able to measure there later, when satellite coverage or location improves. Use GPS planning software to identify the daily best and worst satellite coverage times for your location and then choose measurement times that coincide with optimal GPS performance. This is especially important when operating in the worst GPS locations.
- The AgGPS 432 and AgGPS 442 receivers can track the GPS L2C modernization signal. Additionally, the AgGPS 442 receiver can track the GPS L5 modernization signal and the GLONASS satellite constellation. These signals can help you get positions at the worst times of the day and in the worst locations, but do not guarantee that you will.
- To get a fixed position solution with sub-inch accuracy, initialize the rover receiver. For initialization to take place, the receiver must track at least 5 satellites that the base station is also tracking. In a dual-satellite constellation operation for example, GPS and GLONASS, the receiver must track at least six satellites.
- To maintain a fixed position solution, the rover must continuously track at least four satellites that the base station is also tracking. In a dual-satellite constellation operation, GPS plus GLONASS, the receiver must track at least 5 satellites that the base station is also tracking. The radio link to the base station must be maintained.
- Loss of satellite signals or the loss of radio link results in a loss of sub-inch position accuracy. From Fixed, the receiver changes to Float or Autonomous mode:
 - In Float mode, the rover has a connection to the base station through the radio, but has not yet initialized
 - In Autonomous mode, the rover has lost radio contact with the base station and is working by itself with the available GPS signals.

- On a vehicle, place the GPS antenna in a location as free from shock and vibration as possible. A single magnetic mount is normally sufficient to hold the antenna in a suitable location.
- Make sure that the rover receiver does not lose power. An *AgGPS 432/442* receiver is typically powered by its internal battery. You cannot change the battery, but the charge typically lasts for longer than a working day. If you do not use the rover receiver very often, ensure that it is charged at least every three months.
- For vehicle operation, Trimble recommends that you use an external power source so that the internal battery can be saved for times when the receiver is being used off the vehicle.
- Do not locate the receiver or antenna within 400 meters (1312 ft) of powerful radar, television, cellular communications tower, or other transmitters or GPS antennas. Low-power transmitters, such as those in cellular phones and two-way radios, normally do not interfere with receiver operations. Cellular towers can interfere with the radio and can interfere with GPS signals entering the receiver. High-power signals from a nearby radio or radar transmitter can overwhelm the receiver circuits. This does not harm the receiver, but it can prevent the receiver electronics from functioning correctly.
- Do not use the rover receiver directly beneath or close to overhead power lines or electrical generation facilities. The electromagnetic fields associated with these utilities can interfere with GPS receiver operation. Other sources of electromagnetic interference include:
 - gasoline engines (spark plugs)
 - televisions and computer monitors
 - alternators and generators
 - electric motors
 - equipment with DC-to-AC converters

- fluorescent lights
- switching power supplies
- Trimble recommends that, wherever possible, all GPS receiver equipment is protected from rain or water. Although, the receivers are designed to withstand all wet weather conditions, keeping the receivers dry prolongs the life of the equipment and reduces the effects of corrosion on ports and connectors. If the equipment gets wet, use a clean dry cloth to dry the equipment, and then leave the equipment open to the air to dry. Do not lock wet equipment in a transport case for prolonged periods. Wherever possible, avoid exposing the GPS receiver to corrosive liquids and salt water.
- If you are using the rover receiver in open spaces, Trimble recommends that you stop work during electrical storms where the risk of lightning strike is high.
- Where cables are involved, Trimble recommends that you use cable ties to secure the cables to the rod or other equipment to avoid inadvertent snagging while moving about the jobsite. Be careful not to kink, twist, or unnecessarily extend cables, and avoid trapping them in vehicle doors or windows. Damage to cables can reduce the performance of GPS equipment.

Setting up the Receiver

In this chapter:

- [Common ways to set up a base station](#)

This chapter provides guidelines for setting up the AgGPS 432 / 442 GPS receiver as a base station.

Common ways to set up a base station

You can set up a base station in different ways depending on the application, coverage area, degree of permanence versus mobility, and available infrastructure. Before you set up a base station, please read [Chapter 4, Setup Guidelines](#).

Setting up a base station for permanent installation

A permanent base station helps to eliminate the types of error that can result from repeated daily setups, and ensures that you always use the GPS antenna at the exact original location. The requirement for a permanent base station setup increases as more receivers that use the base station as a source of corrections, increases the cost of any base station downtime.

An AgGPS 432 /442 GPS receiver is used as the base station, located where it is secure from theft and the weather. The GPS antenna are mounted on a permanent structure, such as on the roof of the building, concrete post, or other sturdy mounting point, where it is clear from obstructions. The radio antenna is mounted as high as possible, on a pole, tower or other high structure that can provide the maximum range of operation.

The GPS antenna supplied with the AgGPS 432 /442 GPS receiver is the Trimble Zephyr Geodetic Model 2. This antenna has a large ground plane that eliminates multipath, providing the best GPS performance at the base location. The antennas are connected to the receiver by high quality RF cables.

The receiver is connected to a permanent power supply (mains or generator power).

The internal battery of the receiver is always being charged, and acts as an uninterruptible power supply if there is a power failure.

Setting up a mobile base station: Tripod and fixed height tripod

If you are repeatedly moving between fields, Trimble recommends that you use either a tripod and tribrach setup, or a fixed height tripod.

The fixed height tripod is quicker and easier to set up over a control point. Take great care to ensure that the GPS antenna is set up accurately over the control point, and that the GPS antenna height is measured accurately, in the right way (vertical or slope height) to the right location on the antenna (base of antenna or to a specified location on the antenna). When you start the rover receiver, it is extremely important to check in, at one or more known locations, to check for possible position or height errors.

Checking in at a known location is good practice and can avoid costly errors caused by a bad setup.

Typically, the tripod and fixed height tripod methods do not give significant height clearance above the ground, and can reduce the range of operation caused by radio limitations.

Tripod and tribrach setup

In the tripod setup, the tripod is located over the control point, and the tribrach and tribrach adaptor is mounted on the tripod and centered over the point.

1. Place the external antenna bracket on the tribrach adapter and mount the GPS antenna on the tribrach adaptor sandwiching the external antenna bracket to hold it in place.
2. Clip the GPS receiver to the tripod if desired. Alternatively, the GPS receiver can remain in the carrying case.
3. Connect the GPS antenna to the receiver using the cable provided.

4. If necessary, connect the GPS receiver to an external 12 V power supply using the crocodile clip cable.
5. Mount the external radio antenna to the bracket and connect the antenna to the receiver using the cable provided.

Fixed height tripod setup

A fixed height tripod setup is similar to a tripod setup, but is simplified by the central leg of the tripod, that is placed directly on the control point. If the central leg is leveled accurately, the fixed height tripod is quick and easy to set up, and provides an accurate way to measure the true antenna height.

1. Set up the tripod over the control point.
2. Attach the GPS antenna to the head of the tripod.
3. If using an external high-gain radio antenna, mount the radio antenna to the radio antenna bracket that is attached to the head of the tripod (beneath the GPS antenna).
4. Hook the receiver to the center leg of the tripod, using the tripod clip. Alternatively, the GPS receiver can remain in the carrying case.

External radio-modems

The most common data link for Real-Time Kinematic (RTK) operation is a radio. The AgGPS 432 /442 GPS receiver is available with the following internal radios:

- 410–430 MHz (Tx/Rx, Rx only, or Tx only)
- 430–450 MHz (Tx/Rx, Rx only, or Tx only)
- 450–470 MHz (Tx/Rx, Rx only, or Tx only)
- 900 MHz (Tx/Rx, Rx only, or Tx only)

Note – “Tx” indicates that the radio transmits corrections. “Rx” indicates that the receiver receives corrections. “Tx/Rx” indicates that the radio both transmits and receives corrections.

If the AgGPS 432 /442 GPS receiver does not have an internal transmit radio, or you want to connect to higher power or to a secondary external transmit radio or cellular modem, use the 26-pin port, the Lemo port, or Bluetooth wireless technology.

The AgGPS 432 /442 GPS receiver supports the following Trimble base radios:

- TRIMMARK™ 3 radio
- Trimble SNB900 radio
- Trimble PDL450 radio
- Trimble HPB450 radio

When used with an AgGPS 432 /442 GPS receiver, most external radios require an external power source. Only the Trimble SNB900 radio-modem has an internal battery and does not require external power.

Configure the external radio separately, using either the configuration program for the external radio or the radio display and keypad.

To configure the AgGPS RTK Base for RTK operation, follow the base setup procedure to set the following parameters:

- Set the base station coordinates
- Enable the CMR+™ corrections stream on the selected serial port.

Configuring the Receiver Using the Keypad and Display







In this chapter:

- [Button functions](#)
- [Power button operations](#)
- [Home screen](#)
- [Status screens](#)
- [Configuring the receiver as a base receiver](#)
- [Configuring the AgGPS 432/442 as a rover receiver](#)
- [Configuring system settings](#)
- [Configuring Ethernet settings](#)
- [Configuring the AgGPS 432/442 receiver using a web browser](#)

The receiver features a keypad and display (see [Keypad and display, page 20](#)) so that you can configure the receiver without using a computer.

Button functions

The AgGPS 432 / 442 GPS receiver has seven buttons on the front panel to control the receiver. Use the buttons to turn the receiver on and off and to check or change the receiver settings.

Button	Name	Function
	Power	Turns the receiver on and off. To turn the receiver off, hold the Power button for two seconds
	Escape	Returns to the previous screen or cancels changes being made on a screen.
	Enter	Advances to the next screen or accepts changes made on a screen.
	Up	Moves the cursor between multiple fields on a screen or makes changes to an editable field.
	Down	Moves the cursor between multiple fields on a screen or makes changes to an editable field.
	Left	Moves the cursor between characters in a field that can be changed.
	Right	Moves the cursor between characters in a field that can be changed. Press this button to enter Edit mode.

Power button operations

Press the Power button  to turn the receiver on and off. In addition, you can tap the Power button to return to the Home screen, or hold down the Power button to perform the following operations:

To ...	Hold the  button for ...	Notes
turn off the receiver	two seconds	The display shows a countdown timer. When the display goes blank, release the Power button.
clear the almanac, ephemeris, and SV information	15 seconds	The display show a countdown timer. When the display goes blank, continue to hold the Power button. The display shows a countdown time to clear the almanac and ephemeris. When the counter reaches 0, release the Power button.
reset the receiver to its factory defaults and the default application file	35 seconds	The display show a countdown timer. When the display goes blank, continue to hold the Power button. The display show a countdown to clear the almanac and ephemeris. When the counter reaches 0, continue to hold the Power button. The display indicates a countdown to resetting the receiver. When the counter reaches 0, release the Power button.
force the receiver to power down	at least 60 seconds	If the reset method above does not work, use this method to force the receiver to turn off. When the Power LED goes off, release the Power button.

Home screen



The Home screen is the main screen displayed on the receiver. If the receiver is displaying another screen and is left idle for 60 seconds, you are returned to the Home screen. It shows the following information:

- Number of satellites being tracked
- Internal battery power remaining
- Current mode configuration
- Internal radio activity
- Internal radio channel or network

Status screens

The receiver has several view-only status screens that allow you to review the current settings of the receiver. The status screens provide the following information:

- Position solution and precisions
- CMR IDs
- Base name and code
- Latitude, longitude, and height
- Antenna height
- Horizontal and vertical precision
- Receiver firmware version
- Receiver serial number

To access these screens from the Home screen, press  or .







Configuring the receiver as a base receiver

To set up the AgGPS RTK Base receiver as a base receiver, use AutoBase technology or the receiver keypad.

The AutoBase feature automatically configures the receiver settings for you: there is no need to use the keypad. The receiver obtains a position and outputs RTK corrections on the internal radio. See [Chapter 7, Automatically Setting up a Mobile Base Station Using AutoBase Technology](#).













The receiver is configured step-by-step to ensure that all appropriate settings are configured. To move between steps in the configuration process, press .

Configuring the receiver

1. In the Home screen, press . Use the *Operation Mode* screen to configure system settings, mode settings, or to view the SV (satellite) status. Mode Settings is the default setting.
2. Press . Base is the default setting and cannot be changed.
3. Press . Use the *Base Station* screen to select whether the receiver is going to use a “Here” position or if the current coordinates in the receiver will be changed.
4. Press . When **Edit Current** begins to flash, the receiver is in Edit mode and you can change the current setting.
5. Press . The setting changes to New Base (Here).
6. Press  to accept the change.
7. Press  again. The *Base Name* screen appears. See next.











Changing the name and description of the base station

In the *Base Name* screen:

1. Press . When the first character of the base name begins to flash, the receiver is in Edit mode and you can change the current setting.
2. Press  or  to change the value of the character.
3. Press  to move the cursor to the next character.
4. Repeat [Step 2](#) through [Step 3](#) to enter the name of the base station. The name can be up to 16 characters. Press  to accept the change.
5. Press  again. Use the *Base Code* screen to change the code (description) for the base station. Entering a base code is optional and is not required to operate a base station.
6. Press . When the first character of the base code begins to flash, the receiver is in Edit mode and you can change the current setting.
7. Press  or  to change the value of the character.
8. Press  to move the cursor to the next character.
9. Repeat [Step 7](#) through [Step 8](#) to enter the code of the base station. The code can be up to 16 characters.
10. Press  to accept the change.
11. Press  again. The *Base Latitude* screen appears. See next.





Setting the reference latitude, longitude, and height of the base station







In the *Base Latitude* screen:

1. If the base station was set with a “Here” position, press  to continue. To edit the *Base Latitude* setting, press  to start editing and then use the  and  arrows to change the value of the character to edit.
2. The *Base Longitude* screen is used to change the reference longitude of the base station. The base was set up with a “Here” position, so press .
3. The *Point Height* screen is used to change the reference height of the base station. The base was set up with a “Here” position, so press .
4. Use the *Antenna Type* screen to select the type of antenna used with the receiver. Press . When the antenna name begins to flash, the receiver is in Edit mode and you can select an antenna.
5. Press  to scroll through the antenna models until *Zephyr Geodetic Model 2* appears.
6. Press  to accept the change.
7. Press  again. The *Measured To* screen appears. See next.

Measuring and changing the antenna height









In the *Measured To* screen:

1. Press . When the antenna measurement method begins to flash, the receiver is in Edit mode and you can select an antenna measurement method.
2. Press  to scroll through the measurement methods until APC appears. Press  to accept the change.
3. Press .

4. Use the *Antenna Height* screen to change the height of the antenna. Press . When the first character of the antenna height begins to flash, the receiver is in Edit mode and you can change the antenna height. The antenna height should be set to 0.00 for most applications.
5. Press  or  to change the value of the character.
6. Press  to move the cursor to the next character.
7. Repeat [Step 5](#) through [Step 6](#) to enter the height of the antenna.
8. Press  to accept the change.
9. Press  again. The *Output* screen appears. See next.

Outputting corrections

In the *Output* screen:

1. Press  to enter Edit mode for the port.
2. Press  or  to change which port will be used to output corrections. Select Radio to use the internal radio, or Lemo to use an external radio connected via the Lemo connector.
3. Press  to accept the change.
4. Press  to move the cursor to the *Format* field. The default format is RTK CMR+, which cannot be changed.
5. Press .
6. Use the *NMEA* screen to set up NMEA outputs from the receiver. Press  to accept the default of no NMEA messages.
7. Use the *GSOF* screen to set up GSOF outputs from the receiver. Press  to accept the default of no GSOF messages.
8. Use the *RT17* screen to set up RT17 outputs from the receiver. Press  to accept the default of no RT17 messages.

The Home screen appears and the base setup is complete.

Add:





Configuring the AgGPS 432/442 as a rover receiver

The receiver is configured step-by-step to ensure that all appropriate settings are configured. To move between steps in the configuration process, press .

Configuring the receiver



In the *Home* screen:

1. Press .

Use the *Operation Mode* screen to configure system settings, mode settings, or to view the SV (satellite) status. Mode Settings is the default setting.
2. Press . Use the *Mode* screen to select whether the receiver will operate as a base or as a rover.
3. Press . When the mode begins to flash, the receiver is in Edit mode and you can change this setting.
4. Press  to change to Rover.
5. Press  to accept the change.
6. Press  again to move to the *Elevation mask and RTK mode* screen. See the following procedure.





Changing the elevation mask and RTK mode

In the *Elevation mask and RTK mode* screen:

1. Press . When the value for the current elevation mask begins to flash, the receiver is in Edit mode and you can change the setting.
2. Press  to change the elevation mask to the required value.





Note – Note – Trimble recommends that you do not set the elevation mask to a value lower than 10 degrees.

3. Press  to accept the change.

4. Press .
5. In the *Mode* field, press . When the current mode begins to flash, the receiver is in Edit mode and you can change this setting.
6. Press  to change the desired RTK mode of the receiver.
7. Press  to accept the change.
8. Press  again. The *Antenna Type* screen appears. See the following procedure.



Selecting the antenna

In the *Antenna Type* screen:

1. Press . When the antenna name begins to flash, the receiver is in Edit mode and you can select the type of antenna that is to be used with the receiver.
2. Press  to scroll through the antenna models.
3. Once the correct antenna name appears, press  to accept the change.
4. Press  again. The *NMEA* screen appears. See the following procedure.

Outputting corrections

In the *NMEA* screen, set up outputs from the receiver:











1. Press  to accept the default of no NMEA messages.
2. Use the *GSOF* screen to set up GSOF outputs from the receiver. Press  to accept the default of no GSOF messages.
3. Use the *RT17* screen to set up RT17 outputs from the receiver. Press  to accept the default of no RT17 messages. The *Home* screen appears, and the base setup is complete.



Configuring system settings



You can use the keypad and display of the receiver to configure the following settings:

- Display language
- Display and input units
- Baud rate, parity, data bits, and stop bits for serial ports
- Display power saver
- AutoBase warning

To access the system settings:

1. In the Home screen, press . Use the *Operation Mode* screen to configure system settings or mode settings, and to view the SV (satellite) status. Mode Settings is the default setting.
2. Press . When the operation mode begins to flash, the receiver is in Edit mode and you can change this setting.
3. Press  to change to System Setup.
4. Press  to accept the change.
5. Press  again.
6. Use the *Display Language* screen, if necessary, to change the language. Choose English, Finnish, French, German, Italian, Spanish, or Swedish. Press  to accept the change.
7. Press  again. Use the *Display and Input Units* screen, if necessary, to change the units to Meters or US Feet.
8. Press  to accept the change.
9. Press  again. Use the *Port Settings* screen, if necessary, to change the port.
10. Press  to accept the change.
11. Press  again. Use the *Screen Pwr Savr* screen to choose On, Off, or Auto. If you use the Auto setting, the screen turns off after 60 seconds of inactivity. The Power LED remains lit so that you

can tell if the receiver is on or off. If an error message appears, the screen comes back on. Press  to accept the change and then press  again to move to the next screen.

12. The *Autobase warning* screen appears. See [Chapter 7, Automatically Setting up a Mobile Base Station Using AutoBase Technology](#).
13. Press  to accept the change.
14. Press  again. When the Home screen appears, the system setup is complete.

Configuring Ethernet settings

The AgGPS 432/442 receiver has an Ethernet port so that the receiver can connect to an Ethernet network. You can use the Ethernet network to access, configure, and monitor the receiver. No serial cable connection to the receiver is necessary.

The AgGPS 432/442 receiver requires the following Ethernet settings:

- IP setup: Static or DHCP
- IP address
- Netmask
- Broadcast
- Gateway
- DNS address
- HTTP port

The default setting for the HTTP port is 80. The HTTP port is not assigned by the network. HTTP port 80 is the standard port for web servers. This allows you to connect to the receiver by entering only the IP address of the receiver in a web browser. If the AgGPS 432 / 442 receiver is set up to use a port other than 80, you will need to enter the IP address followed by the port number in a web browser.

- Example of connecting to the receiver using port 80:
http://169.254.1.0
- Example of connecting to the receiver using port 4000:
http://169.254.1.0:4000

The default setting of the AgGPS 432 / 442 receiver is to use DHCP. Using DHCP enables the receiver to obtain the IP address, Netmask, Broadcast, Gateway, and DNS address from the network.

When an AgGPS 432/442 receiver is connected to a network using DHCP, an IP address is assigned to the receiver by the network. To verify the IP address of the receiver, select the up button (⬆) from the keypad when the *Home* screen is displayed. The Ethernet IP address appears as shown.

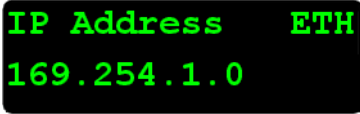

The screenshot shows a black background with green text. The text is arranged in two lines. The first line reads "IP Address" followed by "ETH" on the right. The second line reads "169.254.1.0".

If your network installation requires the receiver to be configured with a static IP address, you can configure the Ethernet settings using the web server or the WinFlash utility. The web server can be only used when the receiver is connected to a network and has a valid Ethernet configuration.

Use the WinFlash utility to configure the Ethernet settings of a receiver that is to be connected to a network that requires static IP addresses:

1. Contact the network administrator for the correct settings for the AgGPS 432/442 receiver.
2. Connect the AgGPS 432/442 receiver to a computer running the WinFlash utility using the serial cable provided with the receiver.
3. Turn on the AgGPS 432/442 receiver.
4. On the computer, start the WinFlash utility.

- From the *Device Configuration* screen, select Trimble AgGPS Receiver. From the *PC serial port* list, select the appropriate PC serial port. Click **Next**:



- From the *Operation Selection* screen, select *Configure ethernet settings*, and then click **Next**:

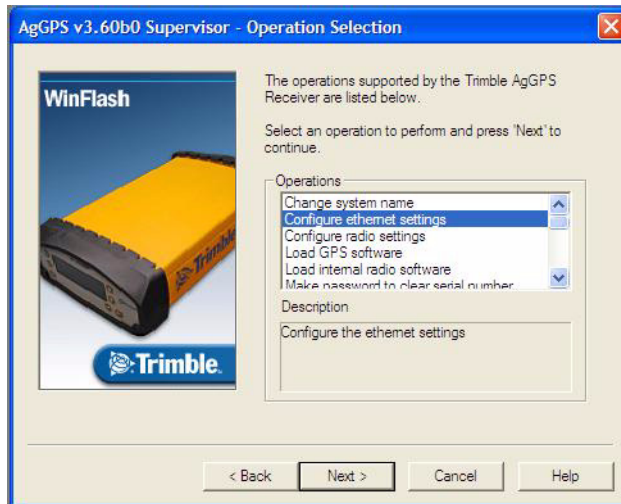

7. From the *Settings Review* screen, click **Finish**:

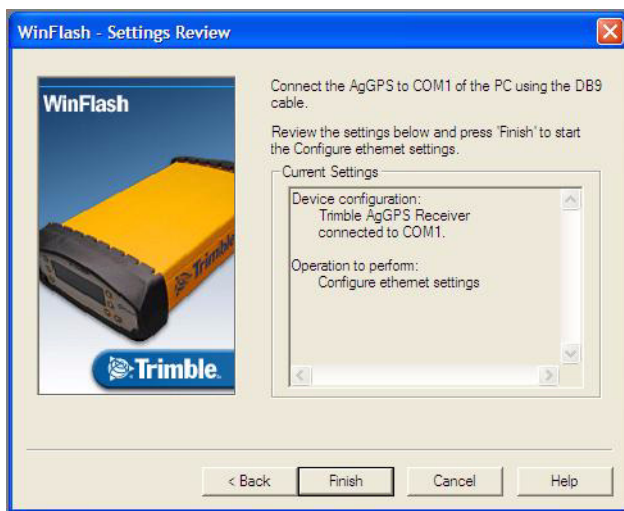

Once the WinFlash utility connects to the receiver, the *Ethernet Configuration* dialog appears.

8. Enter the network settings in the *Ethernet Configuration* dialog and then click **OK**:

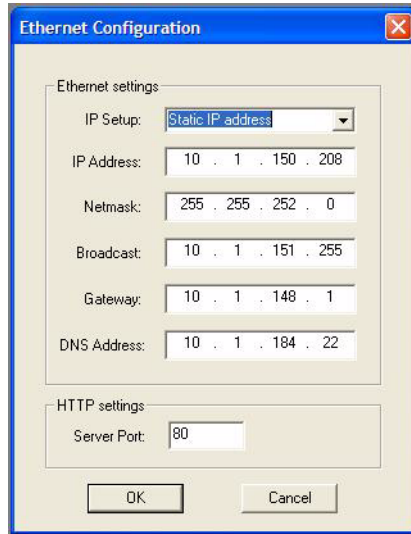

The Broadcast setting is the IP address that is used to broadcast to all devices on the subnet. This is usually the highest address (usually 255) in the subnet.

Configuring the AgGPS 432/442 receiver using a web browser

The AgGPS 432/442 receiver can be configured using the keypad and display, Trimble SCS900 Site Controller software, or a web browser. This section describes how to set up the receiver using a web browser.

Supported browsers

- Mozilla Firefox version 1.07 or later (version 1.50 is recommended for Windows, Macintosh, and Linux operating systems)

- Microsoft Internet Explorer® version 6.00 or later for Windows operating systems

Connecting to the receiver using a web browser

1. Enter the IP address of the receiver into the address bar of the web browser as shown:



2. If security is enabled on the receiver, the web browser prompts you to enter a username and password:

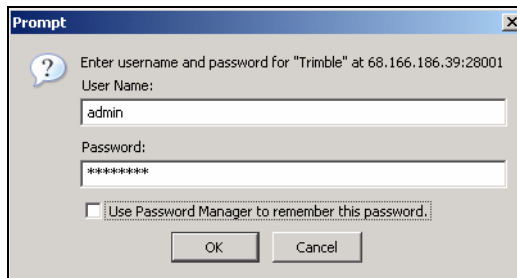

The default login values for the *AgGPS* 432/442 receiver are:

- User Name: admin
- Password: password

If you cannot connect to the receiver, the password for the root account may have been changed, or a different account may be being used. Contact your receiver administrator for the appropriate login information.

Once you are logged in, the AgGPS_442 web page appears:

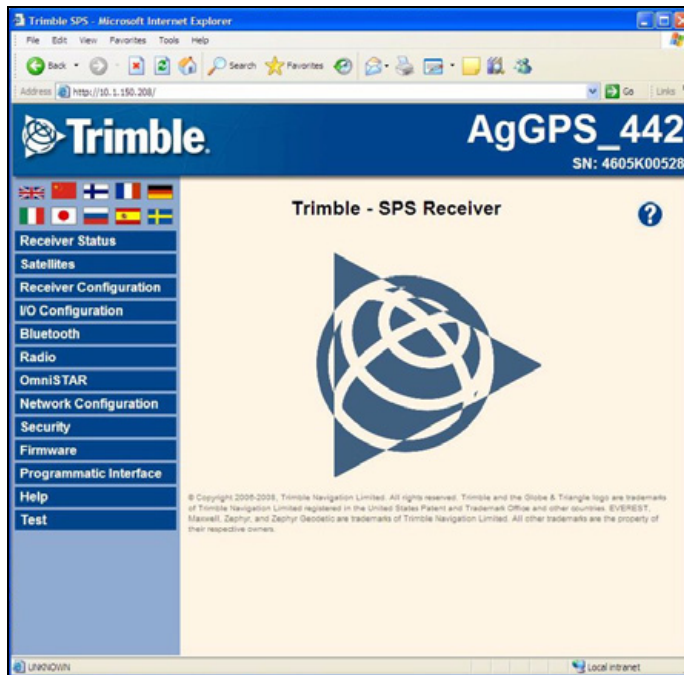

Changing the settings

Use the webpage to configure the receiver settings. The web interface shows the configuration menus on the left of the browser window, and the settings on the right. Each configuration menu contains related submenus to configure the receiver and monitor receiver performance.

***Note** – The configuration menus available vary based on the version of the AgGPS 432/442 receiver.*

A summary of each configuration menu is provided here. For more detailed information about each of the receiver settings, select the *Help* menu.

To display the web interface in another language, click the corresponding country flag. The web interface is available in the following languages:

-
- | | |
|-----------|------------|
| • English | • Italian |
| • German | • Russian |
| • French | • Chinese |
| • Spanish | • Japanese |
-

Receiver Status menu

The *Receiver Status* menu provides a quick link to review the receiver's available options, current firmware version, IP address, temperature, runtime, satellites tracked, current outputs, available memory, position information, and more.

This figure shows an example of the screen that appears when you select *Receiver Status / Identity*:

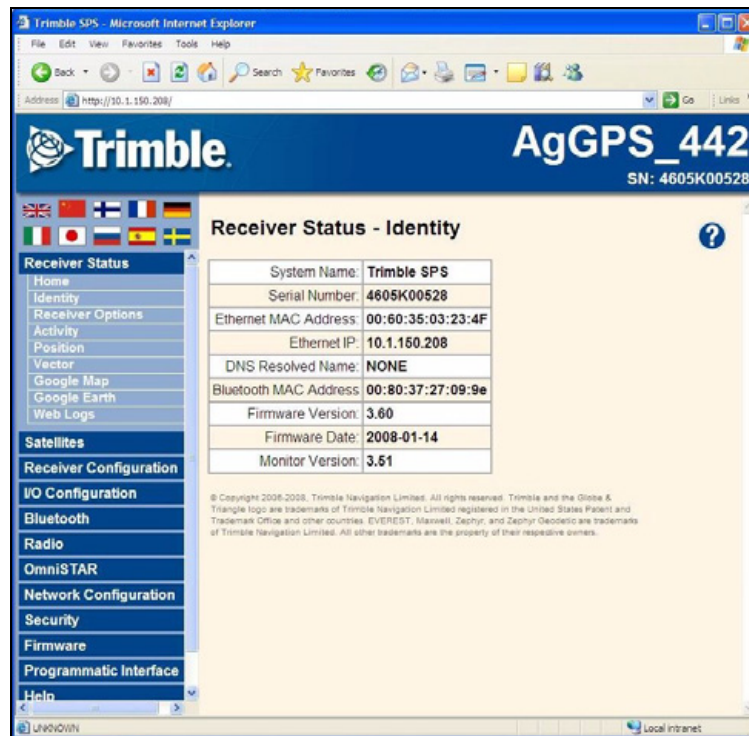

The screenshot shows a web browser window titled "Trimble SPS - Microsoft Internet Explorer" with the address bar showing "http://10.1.150.208/". The page header includes the Trimble logo and "AgGPS_442" with the serial number "SN: 4605K00528". A navigation menu on the left lists various settings categories. The main content area is titled "Receiver Status - Identity" and contains a table of system information.

System Name:	Trimble SPS
Serial Number:	4605K00528
Ethernet MAC Address:	00:60:35:03:23:4F
Ethernet IP:	10.1.150.208
DNS Resolved Name:	NONE
Bluetooth MAC Address:	00:80:37:27:09:9e
Firmware Version:	3.60
Firmware Date:	2008-01-14
Monitor Version:	3.51

© Copyright 2006-2008, Trimble Navigation Limited. All rights reserved. Trimble and the Globe & Triangle logo are trademarks of Trimble Navigation Limited registered in the United States Patent and Trademark Office and other countries. EVEREST, Maxwell, Zephyr, and Zephyr Geodetic are trademarks of Trimble Navigation Limited. All other trademarks are the property of their respective owners.

Satellites menu

Use the *Satellites* menu to view satellite tracking details and enable/disable GPS, GLONASS, and SBAS (WAAS/EGNOS and MSAS) satellites.

Note – To configure the receiver for OmniSTAR, use the OmniSTAR menu. See page 70.

This figure shows an example of the screen that appears when you select *Satellite /Tracking (Sky Plot)*:

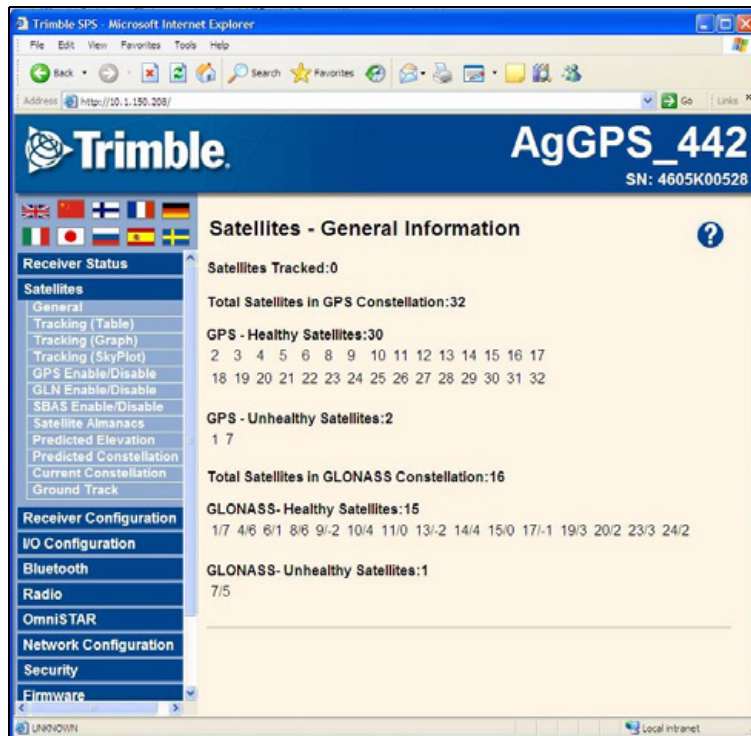

Receiver Configuration menu

Use the *Receiver Configuration* menu to configure such settings as elevation mask and PDOP mask, the antenna type and height, the reference station position, and the reference station name and code.

This figure shows an example of the screen that appears when you select *Receiver Configuration / Summary*:

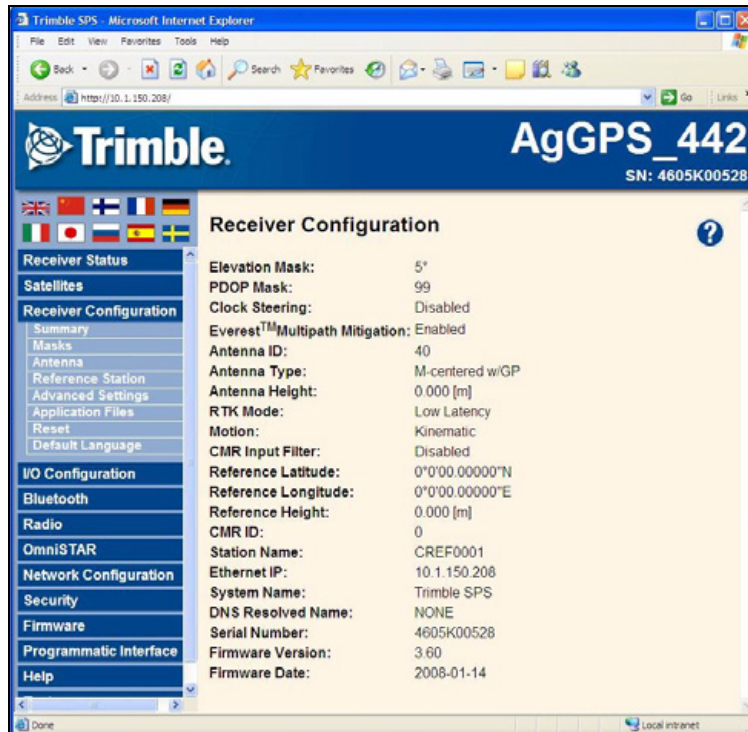

I/O Configuration menu

Use the I/O Configuration menu to set up all outputs of the AgGPS 432/442 receiver. The receiver can output CMR, RTCM, NMEA, GSOF, RT17, or BINEX messages. These messages can be output on TCP/IP, UDP, serial, Bluetooth, or radio ports.

This figure shows an example of the screen that appears when you select *I/O Configuration / Port Summary*:

Type	Port	Input	Output
TCP/IP	5017	-	-
TCP/IP	5018	-	-
NTripClient	-	-	-
NTripServer	-	-	-
NTripCaster 1	8000	-	-
NTripCaster 2	8001	-	-
NTripCaster 3	8002	-	-
Serial	Lemo (38 4K-8N1)	-	-
Serial	Modem 1 (115K-8N1)	-	NMEA-GGA(1Hz) GSOF 1PPS
Serial	Modem 2 (115K-8N1)	-	-
Bluetooth	1	-	-
Bluetooth	2	-	-
Bluetooth	3	-	-
USB	-	-	-
Radio	-	-	-

Radio menu

Use the *Radio* menu to configure the internal radio of the receiver, if applicable. The AgGPS 432/442 receivers are available with 410-430 MHz, 430-450 MHz, 450-470 MHz, or 900 MHz radios. This figure shows examples of the screens that appears when you select *Radio*:

900 MHz radio:

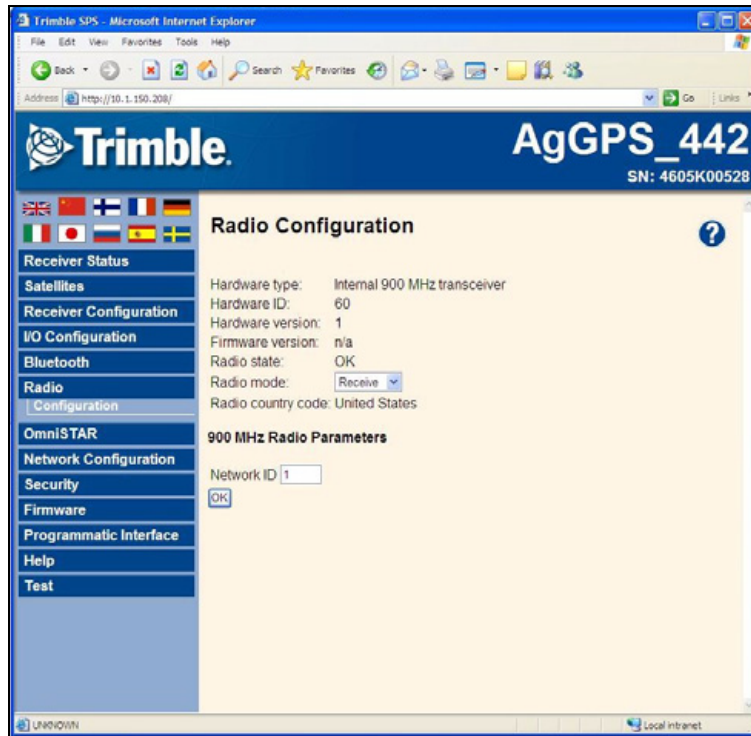

450 MHz radio

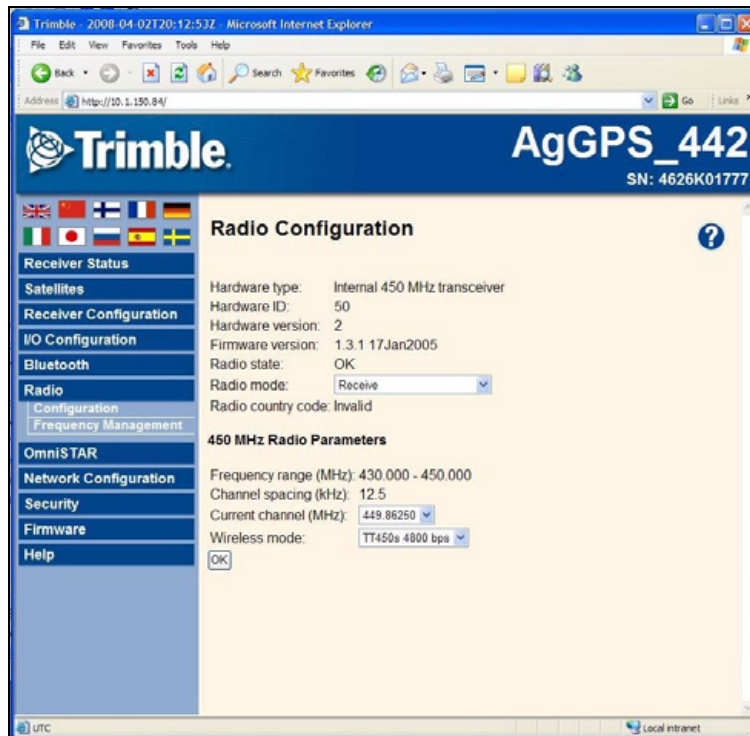

Omnistar menu

All AgGPS 432/442 receivers can receive Omnistar corrections. By default, Omnistar tracking is turned on in the receiver. To receive Omnistar corrections, you must set the receiver to track Omnistar satellites and it must have a valid Omnistar subscription. The receiver can position with Omnistar XP or HP. To purchase a subscription for your receiver, contact Omnistar at:

www.Omnistar.com

North & South America, 1-888-883-8476 or 1-713-785-5850

Europe & Northern Africa, 31-70-317-0900

Australia & Asia, 61-8-9322 5295

Southern Africa, 27 21 552 0535

This figure shows an example of the screen that appears when you select *Omnistar / Configuration*:

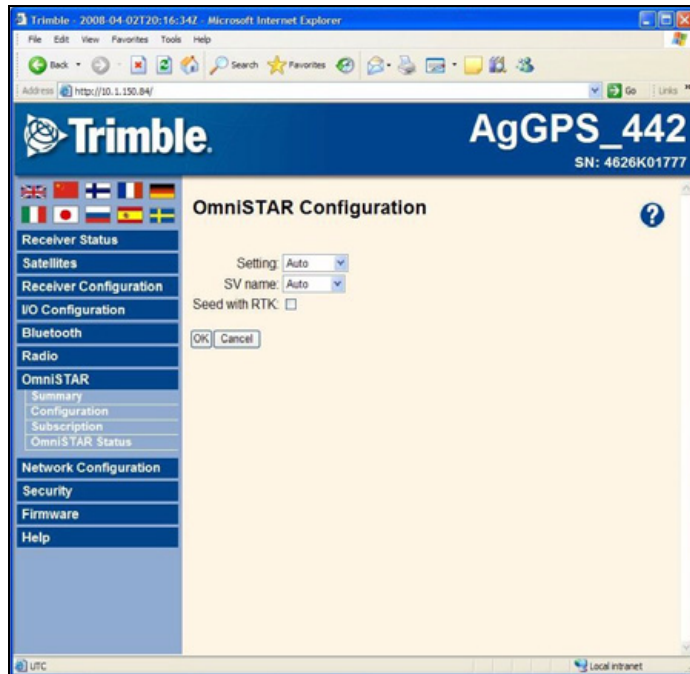

Internet Configuration menu

Use the *Internet Configuration* menu to configure Ethernet settings, email alerts, PPP connection, HTTP port, FTP port, and VFD port settings of the receiver. For information on the Ethernet settings, see [Configuring Ethernet settings, page 56](#).

The VFD port allows you to use the *AgGPS 432/442Remote Control* application to view and navigate the *AgGPS 432/442receiver* through a mock display and keypad interface. To allow the *AgGPS 432/442Remote Control* to connect to the receiver, you need to enable the VFD port. To do this, select *Internet Configuration / VFD*.

This figure shows an example of the screen that appears when you select *Network Configuration / Ethernet*:



Security menu

Use the *Security Configuration* menu to enable and disable security settings and to add and edit Users.

This figure shows an example of the screen that appears when you select *Security*:



Automatically Setting up a Mobile Base Station Using AutoBase Technology

In this chapter:

- AutoBase Warning
- Working with AutoBase technology
- Scenario One: First visit to a site with AutoBase Warning turned off
- Scenario Two: First visit to a site with AutoBase Warning turned on
- Scenario Three: Repeat visit to a site with AutoBase Warning turned off
- Scenario Four: Repeat visit to a site with AutoBase Warning turned on
- The AutoBase process

The AutoBase technology is a feature of the Trimble AgGPS 432/442 receiver that enables you to reduce daily setup time for mobile base stations and to reduce the likelihood of using incorrect base station coordinates during setup.

The AutoBase feature allows you to set up a receiver as a base station receiver and save you time so you do not need to reconfigure the receiver at the start of each day. It also allows you to set up the base station on a new site without needing to configure the settings in the receiver.

Even if you have used the AutoBase feature in other Trimble receivers, Trimble recommends that you read this chapter carefully because new functions in this feature provide greater benefit to you.

AutoBase Warning

The AutoBase Warning, when enabled, prevents the receiver from creating a new base station position and beginning operating as an RTK base station when no previous base station position exists that corresponds to the current position of the receiver.

When the AutoBase Warning is on, the receiver will not begin transmitting RTK corrections from a base position (latitude, longitude, and height) that is not a part of the GPS site calibration. When the AutoBase Warning is off, the receiver begins transmitting RTK corrections from a new base position. You need only turn on the receiver the first time on a point, and you do not need to manually configure the base station settings.

By default, the receiver has the AutoBase Warning turned on. The receiver uses the AutoBase Warning setting to control how the receiver performs when different criteria are met. You can turn the AutoBase Warning on or off using the keypad and display. For more information, see [Configuring system settings, page 55](#).

Working with AutoBase technology

This section contains some example scenarios. In each section, there is a step-by-step process that explains what you will experience in each scenario.

Scenario One: First visit to a site with AutoBase Warning turned off

The following actions occur when you set up the base station for the first time on a new point and the AutoBase Warning is turned off:

1. You turn on the receiver.
2. The receiver begins tracking satellites.
3. The receiver determines the current position.

4. The receiver reviews the previous base station positions stored in the receiver.
5. The receiver does not find any base station that corresponds to the current position.
6. The receiver creates a new base station location for the current location.
7. The receiver sets the antenna height to 0. The antenna height is measured to the antenna phase center.



CAUTION – On each reoccupation of the point, you must ensure that the receiver antenna is set up in exactly the same location and at exactly the same height. Trimble also recommends that you use a T-bar or Fixed height tripod so that the position is easy to re-establish. Failure to achieve the same height position for the antenna results in errors in heights in subsequent measurements.

Where you set up each time with potentially different antenna heights, Trimble recommends that on the first setup after AutoBase has completed its process, that you edit the antenna height (using the receiver keypad and display). The updated antenna height changes the AutoBase setup, so that on subsequent setups, when you again change the antenna height, you will get correct height information during measurement. At the first setup, Trimble recommends that you change the AutoBase setup and antenna height *before* you carry out a site calibration.

8. The receiver begins generating RTK CMR+ corrections.
9. The RTK corrections begin streaming over the internal radio. If there is no internal radio, the receiver defaults to streaming the corrections on the Lemo port.

Scenario Two: First visit to a site with AutoBase Warning turned on

The following actions occur when you set up the base station for the first time on a point, and the AutoBase Warning is turned on:

1. You turn on the receiver.
2. The receiver begins tracking satellites.
3. The receiver determines the current position.
4. The receiver reviews the base positions stored in the receiver.
5. The receiver does not find any base station that corresponds to the current position.
6. The receiver displays a warning that AutoBase has failed.
7. No RTK corrections are streamed until the base station is set up using the keypad and display.

Scenario Three: Repeat visit to a site with AutoBase Warning turned off

The following actions occur when you repeat a base station setup on a point, and the AutoBase Warning is turned off:

1. You turn on the receiver.
2. The receiver begins tracking satellites.
3. The receiver determines the current position.
4. The receiver reviews the base station positions stored in the receiver.
5. The receiver finds a base station position that corresponds to the current position.



CAUTION – If there are two or more base positions within a 50 meter radius of your current position, the receiver will make the most recently used base position file active.

6. The antenna type, antenna height, and measurement method used in the previous setup of this base station are applied.



CAUTION – If the antenna height is different to the previous setup, then you must enter the corrected height for the antenna (using the keypad and display) before starting measurements. Failure to achieve the correct antenna height position for the antenna results in errors in heights in subsequent measurements.

7. The receiver begins generating RTK CMR+ messages.
8. The RTK corrections begin streaming on the radio or Lemo port defined in the application file.

Scenario Four: Repeat visit to a site with AutoBase Warning turned on

The following actions occur when you repeat a base station setup on a point, and the AutoBase Warning is turned on:

1. You turn on the receiver.
2. The receiver begins tracking satellites.
3. The receiver determines the current position.
4. The receiver reviews the base station positions stored in the receiver.
5. The receiver finds a base station position that corresponds to the current position.



CAUTION – If there are two or more base positions within a 50 meter radius of your current position, the receiver will make the most recently created base position file active.

6. Since a base station position is found, the AutoBase warning does not appear.
7. The receiver loads the previous base information.

8. The antenna type, antenna height, and measurement method used in the previous setup of this base station are applied.



CAUTION – If the antenna height is different from the previous setup, then you must enter the corrected height for the antenna (using the keypad and display) before starting measurements. Failure to achieve the correct antenna height position for the antenna results in errors in heights in subsequent measurements.

9. The receiver begins generating RTK CMR+ corrections.
10. The RTK corrections begin streaming on the radio or port defined in the previous setup of this base station.

***Note** – AutoBase recalls base station positions that are stored in the receiver. If the receiver has been previously set up on a control point but the stored base station position is not found in the receiver, it is possible that the information may have accidentally been deleted. In this case, use the display and keypad to manually set up the base station. Make sure that you use the same base station latitude, longitude, and height as in the previous setup otherwise you will experience position or height errors in all subsequent measurements.*

Trimble recommends that after any new base station setup, or at the start of each measurement session, you measure a known point to verify that position and height errors are within tolerance. This is good practice and it takes just a few seconds to eliminate potentially gross errors typically associated with repeated daily base station setups.

The AutoBase process

Figure 7.1 shows the AutoBase process:

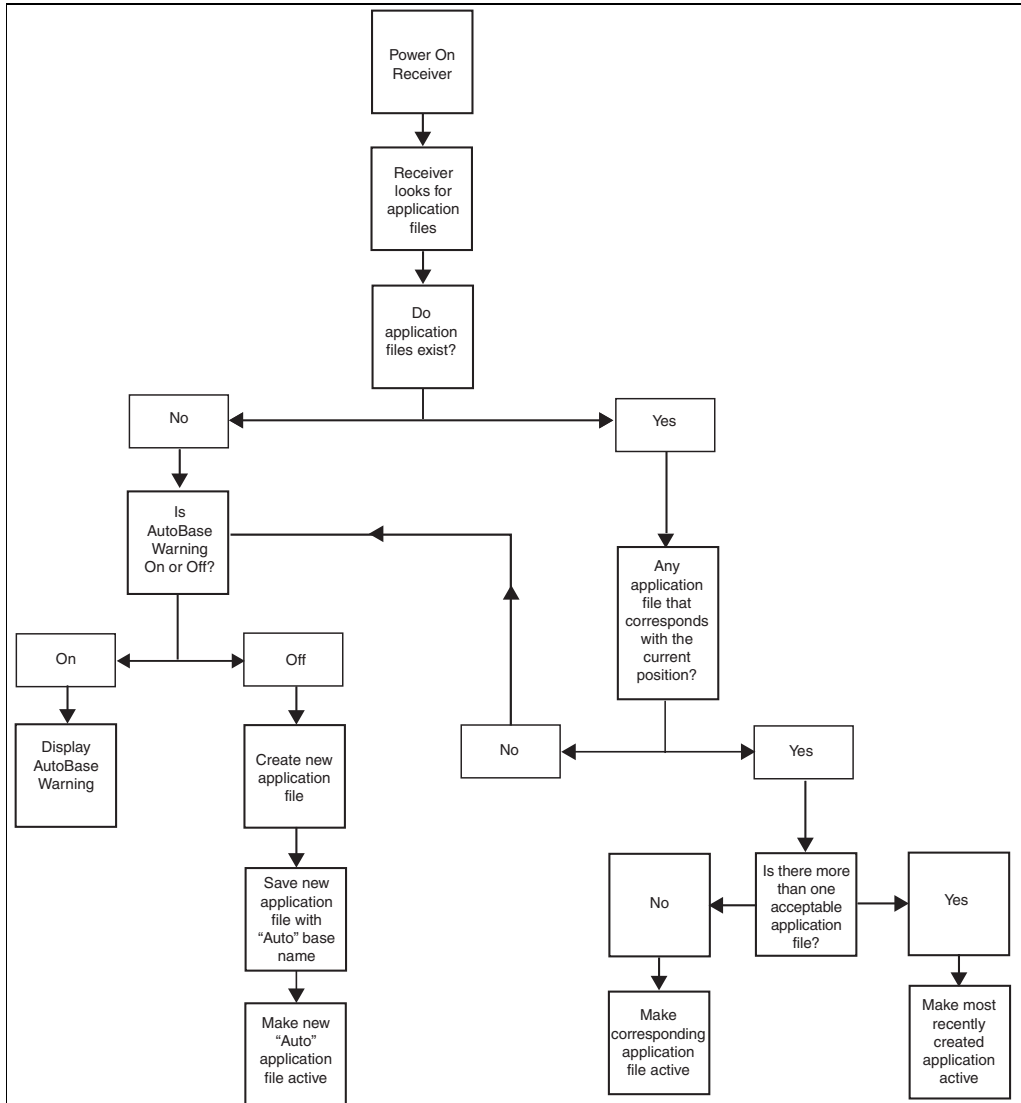

Figure 7.1 Autobase process flowchart

Default Settings

In this chapter:

- [Default receiver settings](#)
- [Resetting the receiver to factory defaults](#)

All settings are stored in application files. The default application file, `Default.cfg`, is stored permanently in the receiver, and contains the factory default settings for the AgGPS RTK Base 450/900 receiver. Whenever the receiver is reset to its factory defaults, the current settings (stored in the current application file, `Current.cfg`) are reset to the values in the default application file.

Default receiver settings

These settings are defined in the default application file.

Function	Factory default
SV Enable	All SVs enabled
General Controls:	Elevation mask
	PDOP mask
	RTK positioning mode
	Motion
Lemo Port:	Baud rate
	Format
	Flow control
Modem Port:	Baud rate
	Format
	Flow control
Input Setup:	Station
NMEA/ASCII (all supported messages)	All ports Off
Streamed output	All types Off Offset = 00
RT17/Binary	All ports Off
Reference position:	Latitude
	Longitude
	Altitude
Antenna:	Type
	Height (true vertical)
	Measurement method

Resetting the receiver to factory defaults

To reset the receiver to its factory defaults, press  for 35 seconds.

Specifications

In this chapter:

- General specifications
- Physical specifications
- Electrical specifications
- Communication specifications

This chapter details the specifications for the AgGPS 432 / 442 receivers.

Specifications are subject to change without notice.

General specifications

Feature	Specification
Keyboard and display	VFD display 16 characters by 2 rows On/Off key for one button startup using AutoBase technology Escape and Enter key for menu navigation
Receiver type	Modular GPS receiver
Antenna type	Zephyr Geodetic Model 2 Also supports legacy Trimble antennas Zephyr™, Zephyr Geodetic, Micro-Centered™, Z+ Choke Ring, Rugged Micro-Centered.

Physical specifications

Feature	Specification
Dimensions (L x W x H)	24 cm (9.4 in) x 12 cm (4.7 in) x 5 cm (1.9 in) including connectors
Weight	1.65 kg (3.64 lbs) receiver with internal battery and radio 1.55 kg (3.42 lbs) receiver with internal battery and no radio
Temperature	
Operating	−40 °C to +65 °C (−40 °F to +149 °F)
Storage	−40 °C to +80 °C (−40 °F to +176 °F)
Humidity	100%, condensing
Waterproof	IP67 for submersion to depth of 1 m (3.28 ft)
Shock and vibration	Tested and meets the following environmental standards:
Shock, non operating	Designed to survive a 2 m (6.6 ft) pole drop onto concrete MIL-STD-810F, Fig. 514.5C-17
Shock, operating	To 40 g, 10 ms, saw-tooth
Vibration	MIL-STD-810F, Fig 514.5C-17
Measurements	Advanced Trimble Maxwell™ Custom GPS chip Proven Trimble low elevation tracking technology

Electrical specifications

Feature	Specification
Power	
Internal	<p>Integrated internal battery 7.4 V, 7800 mA-hr, Lithium-ion</p> <p>Internal battery operates as a UPS in the event of external power source outage</p> <p>Internal battery will charge from external power source when input voltage is >15 V</p> <p>Integrated charging circuitry</p>
External	<p>Power input on Lemo 7-P0S is optimized for lead acid batteries with a cut-off threshold of 10.5 V</p> <p>Power source supply (Internal / External) is hot-swap capable in the event of power source removal or cut off</p> <p>9 V to 30 V DC external power input with over-voltage protection</p> <p>Receiver will automatically turn on when connected to external power source of 15 V or greater</p>
Power consumption	<8 W in RTK Base mode with internal transmit radio
Base station operation times on internal battery	Typically 8–10 hours based on transmitter power, types of messages transmitted, and temperature
Rover operation times on internal battery	Typically 12 hours, varies with temperature.
Certification	<p>Part 15.247 and Part 90 FCC certifications</p> <p>Class B Device FCC Part 15 and ICES-003 certifications</p> <p>RSS-310, RSS-210 and RSS-119 Industry Canada certifications</p> <p>ACMA AS/NZS 4295 approval</p> <p>CE mark compliance</p> <p>C-tick mark compliance</p> <p>UN ST/SG/AC 10.11/Rev. 3 Amend. 1 (Li-ion Battery)</p> <p>UN ST/SG/AC 10/27/Add. 2 (Li-ion Battery)</p> <p>WEEE</p>

Communication specifications

Feature	Specification
Communications	
Port 1 (7-pin 05 Lemo)	3-wire RS-232/CAN
Port 2 (D-sub 26-pin)	Full RS-232 (through multi-port adaptor) 3-wire RS-232
Bluetooth	USB (On the Go) Ethernet Fully-integrated, fully-sealed 2.4 GHz Bluetooth ¹
Integrated radios (optional)	Fully-integrated, fully-sealed internal 450 MHz, Tx, Rx, or Tx/Rx Fully-integrated, fully-sealed internal 900 MHz, Tx, Rx, or Tx/Rx
Channel spacing (450 MHz)	12.5 KHz or 25 KHz spacing available
Frequency approvals (900 MHz)	USA (-10), Australia (-30), New Zealand (-20)
450 MHz transmitter radio power output	0.5 W / 2.0 W
900 MHz transmitter radio power output	1.0 W
Data output	Proprietary Trimble Ag CMR+

¹ Bluetooth type approvals are country specific. For more information, contact your local Trimble office or representative.

Required Radio and GPS Rover Firmware

In this appendix:

- [Radio firmware](#)

This appendix describes the radios and radio firmware versions that are compatible with the *AgGPS 432/442* receivers.

Radio firmware

The following table shows the compatible firmware versions for 900 MHz rover and repeater radios:

Radio firmware compatibility chart	Rover repeater radio							
	SiteNet 900 v 1.43 turbo = OFF	SiteNet 900 v 1.43 turbo = ON	SiteNet 900 v 1.44 turbo = OFF	SiteNet 900 v 1.44 turbo = ON	SiteNet 900 v 2.	AgGPS 442 rover	AgGPS 900 v 1.44	AgGPS 900 v 1.45
Base radio								
SiteNet 900 v1.43 turbo = OFF	OK	N/S	OK	N/S	N/S	N/S	N/S	N/S
SiteNet 900 v1.43 turbo = ON	N/S	OK	N/S	N/S	N/S	N/S	N/S	N/S
SiteNet 900 v1.44 turbo = OFF	OK	N/S	OK	N/C	OK	N/C	OK	OK
SiteNet 900 v1.44 turbo = ON	N/S	N/S	N/C	OK	OK	N/C	OK	OK
SiteNet 900 v2.74	N/S	N/S	OK	OK	OK	OK	OK	OK
AgGPS 442	N/S	N/S	N/C	N/C	OK	OK	N/C	OK
	OK = compatible N/C = not compatible N/S = not supported							

Table A.1 Compatible radio firmware versions

The *AgGPS* 332 / 442 with 450 MHz internal radio is compatible with the:

- SiteNet™ 450 radio
- PDLFix 450
- PDL 450 radio
- *AgGPS* 450 radio

The *AgGPS* 432 / 442 receiver is compatible with the SNB900 version 1.20 or higher.

GPS rover firmware

Version 3.1 or greater firmware is required on the *AgGPS* 252 and *AgGPS* 332 receivers. Version 3.3 or greater is required on the *AgGPS* 442 GNSS receiver.

The *AgGPS* 214 will not accept corrections from the *AgGPS* 442 receiver.

Upgrading the Receiver Firmware

In this appendix:

- [The WinFlash utility](#)
- [Upgrading the receiver firmware](#)
- [Forcing the receiver into Monitor mode](#)

The GPS receiver is supplied with the latest version of the receiver firmware already installed. If a later version of the firmware becomes available, use the WinFlash utility to upgrade the firmware on your receiver.

Firmware updates are available to download from the Trimble website. Go to www.trimble.com/support.shtml and select the link to the receiver that you need updates for and then click Downloads.

The WinFlash utility

The WinFlash utility communicates with Trimble products to perform various functions including:

- installing software, firmware, and option upgrades
- running diagnostics (for example, retrieving configuration information)
- configuring radios

For more information, online help is also available when using the WinFlash utility.

***Note** – The WinFlash utility runs on Microsoft Windows 95, 98, Windows NT[®], 2000, Me, or XP operating systems.*

Installing the WinFlash utility

The WinFlash utility guides you through the firmware upgrade process, as described below. For more information, refer to the WinFlash Help.

You can install the WinFlash utility from the Trimble website.

Upgrading the receiver firmware

1. Start the WinFlash utility. The *Device Configuration* screen appears.
2. From the *Device type* list, select Trimble AgGPS Receiver.
3. From the *PC serial port* field, select the serial (COM) port on the computer that the receiver is connected to.

4. Click **Next**.

The *Operation Selection* screen appears. The *Operations* list shows all of the supported operations for the selected device. A description of the selected operation is shown in the *Description* field.

5. Select *Load GPS software* and then click **Next**.

The *GPS Software Selection* window appears. This screen prompts you to select the software that you want to install on the receiver.

6. From the *Available Software* list, select the latest version and then click **Next**.

The *Settings Review* window appears. This screen prompts you to connect the receiver, suggests a connection method, and then lists the receiver configuration and selected operation.

7. If all is correct, click **Finish**.

Based on the selections shown above, the *Software Upgrade* window appears and shows the status of the operation (for example, **Establishing communication with <your receiver>. Please wait.**).

8. Click **OK**.

The *Software Upgrade* window appears again and states that the operation was completed successfully.



9. To select another operation, click **Menu**; to quit, click **Exit**.

If you click **Exit**, the system prompts you to confirm.

10. Click **OK**.

Forcing the receiver into Monitor mode

If the receiver will not go into Monitor mode to load new firmware, complete the following steps:

1. Turn off the receiver.
2. Press and hold  while turning on the receiver.
3. Continue to hold the  button as the display shows the countdown timer.
4. Once the display shows **Remote Monitor Active:1**, release the  button.

The receiver is forced into Monitor mode and you can load the new firmware.

Troubleshooting

In this appendix:

- [Receiver issues](#)

Use this appendix to identify and solve common problems that may occur with the receiver.

Please read this section before you contact Technical Support.

Receiver issues

This section describes some possible receiver issues, possible causes, and how to solve them.

Issue	Possible cause	Solution
The receiver does not turn on.	External power is too low.	Check the charge on the external battery and, if applicable, check the fuse.
	Internal power is too low.	Check the charge on the internal battery.
	External power is not properly connected.	Check that the Lemo connector or 26-pin adaptor is seated correctly, and that the cable is secured to the receiver. Check for broken or bent pins in the connector.
	Faulty power cable.	Check that you are using the correct cable for the port/battery. Check that the correct battery is connected to a particular port. The ports on the GPS receiver are optimized for use with different types of battery. The Lemo port is optimized for external 12 V batteries such as car, motorcycle, or truck batteries.
The receiver is not responding.	Receiver needs a soft reset.	Turn off the receiver and then turn it back on again.
	Receiver needs a full reset.	Press  for 35 seconds.

Issue	Possible cause	Solution
<p>The base station receiver is not broadcasting.</p>	<p>Corrections are routed to a port rather than to the internal radio modem.</p>	<p>Check that corrections are routed correctly using the receiver keypad and display.</p>
	<p>Poor radio antenna connections</p>	<p>Check that the antenna connections are made correctly. Ensure that the connectors are seated tightly and that there are no signs of damage to the cables.</p>
	<p>You are using AutoBase and the AutoBase Warning function is enabled.</p>	<p>If you set up on a new point on a site that has not been occupied previously, the AutoBase Warning will prohibit the base station from broadcasting.</p>
	<p>Faulty cable between receiver and radio.</p>	<p>Try a different cable. Examine the ports for missing pins. Use a multimeter to check pinouts.</p>
<p>No power to external radio.</p>	<p>No power to external radio.</p>	<p>If the radio has its own power supply, check the charge and connections.</p>
		<p>If power is routed through the receiver, ensure that the receiver's external power source is charged and that power output on Port 3 is enabled.</p>

Issue	Possible cause	Solution
The receiver is not receiving satellite signals	The GPS antenna is connected to the wrong antenna connector.	Make sure that the GPS antenna cable is tightly seated in the GPS antenna connection on the receiver and not connected to the wrong / radio antenna connector.
	The GPS antenna cable is loose.	Make sure that the GPS antenna cable is tightly seated in the GPS antenna connection on the GPS antenna.
	The cable is damaged.	Check the cable for any signs of damage. A damaged cable can inhibit signal detection from the antenna at the receiver.
	The GPS antenna is not in clear line of sight to the sky.	<ul style="list-style-type: none">• Make sure that the GPS antenna is located with a clear view of the sky.• Restart the receiver as a last resort (turn it off and then turn it on again).

Drawings

In this appendix:

- [Back view](#)
- [Side view](#)
- [Bottom view](#)

The drawings in this appendix show the dimensions of the receiver. Refer to these drawings if you need to build mounting brackets and housings for the receiver.

The dimensions shown in these drawings are inches, with millimeters shown in brackets.

Back view

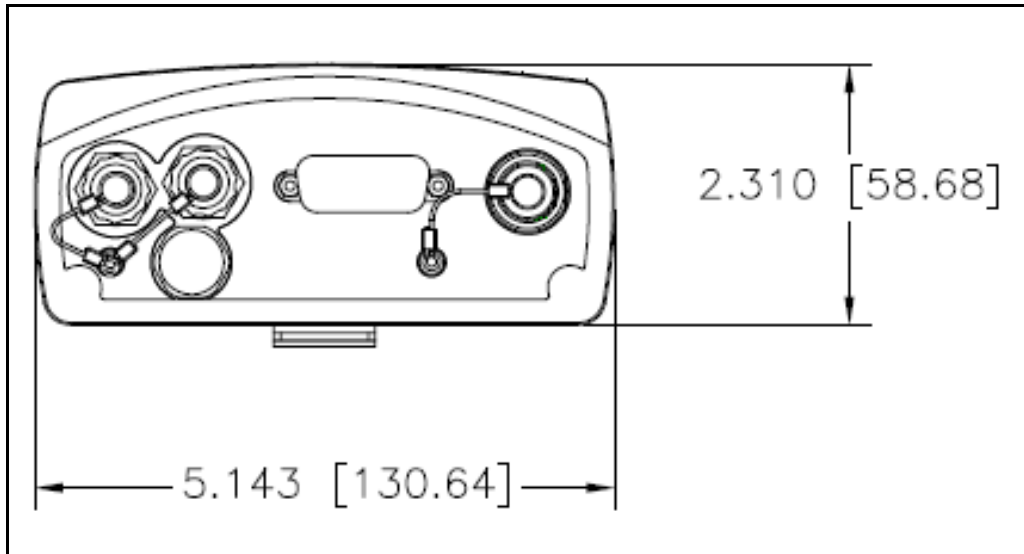

Side view

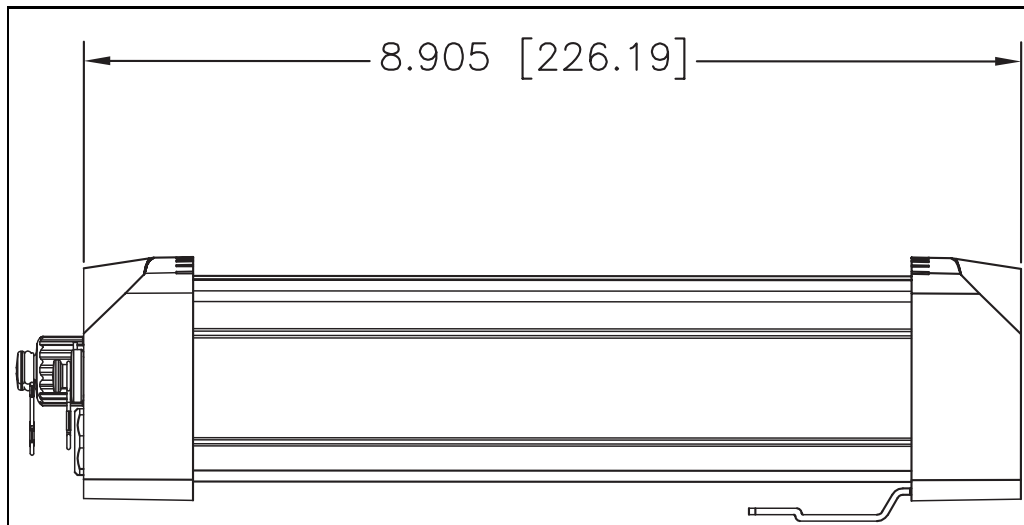

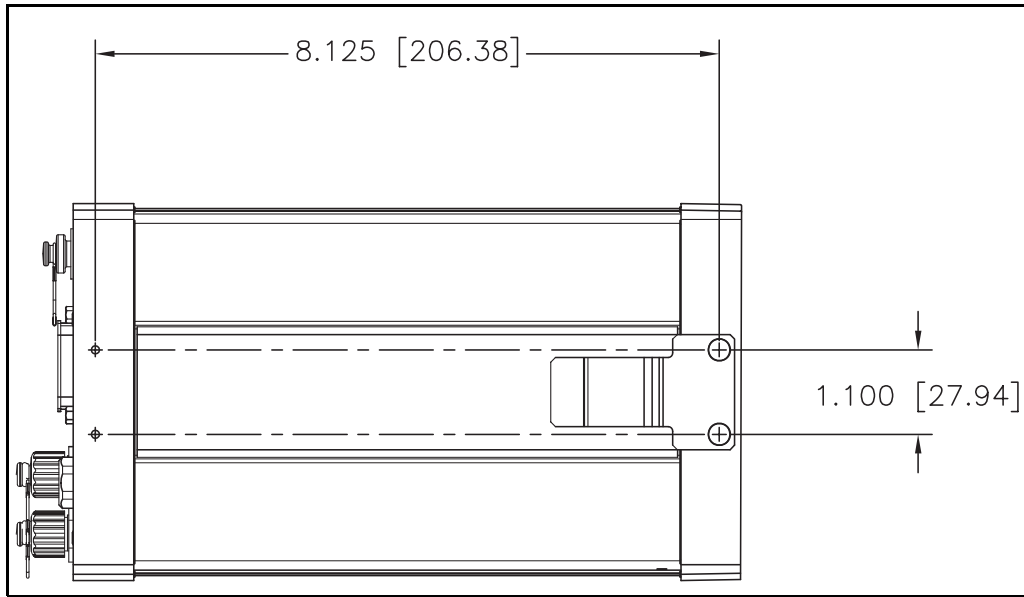
Bottom view

Receiver Connector Pinout Information

In this appendix:

- Lemo connector
- Modem multi-function port

The receivers have a wide range of interfacing options. There are a large number of adaptors and cables available from Trimble that provide most of the common interfacing combinations.

The receiver has two connectors:

- a zero shell 7-pin lemo connector
- a high-density 26-pin D-sub connector

Lemo connector

The lemo connector is a 7-pin zero shell lemo connector.

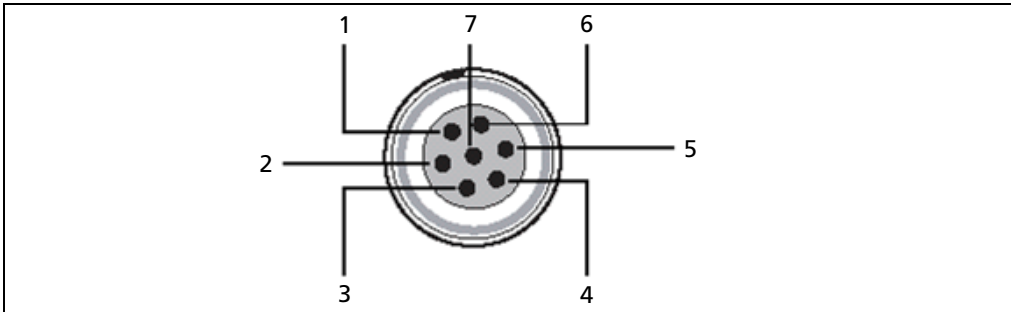

Pin	Usage
1	RS-232 Signal GND
2	GND
3	RS-232 TX data out
4	CAN-
5	CAN+
6	DC Power In (+) 10.5-28 V DC
7	RS-232 Serial data in

Modem multi-function port

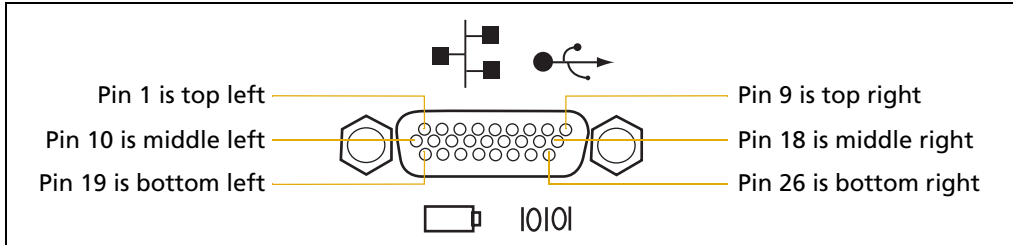

Pin	Usage
1	RS-232 Modem port data terminal ready (DTR)
2	RS-232 Modem port clear to send (CTS)
3	RS-232 Modem port Data Set Ready (DSR)
4	RS-232 Modem port Data Carrier Detect (DCD)
5	RS-232 Modem port Ring Indicator (RI)
6	GND
7	RS-232 Modem port 2 Transmit Data (TX)
8	RS-232 Modem port 2 Receive Data (RX)
9	USB+
10	Ethernet Ground (ET_GND RJ45 Pin 4)
11	RS-232 Modem port Ready to Send (TX)
12	RS-232 Modem port Transmit Data (TX)
13	Ethernet Ground (GND RJ45 Pin 5)
14	Ethernet Ground (GND RJ45 Pin 8)
15	USB ID
16	Ethernet Receive Data+ (RD-RJ45 Pin 6)
17	Ethernet Transmit Data+ (RD-RJ45 Pin 2)
18	USB-
19	USB Power
20	Not Used (60062-xx) 1PPS (62062-xx)
21	RS-232 Modem Port Receive Data (RX)
22	Ethernet Ground (GND RJ45 Pin 7)

E Receiver Connector Pinout Information

Pin	Usage
23	GND
24	DC Power In 9–28 V DC
25	Ethernet Receive Data+ (RD+, RJ45 Pin 3)
26	Ethernet Transmit Data+ (TD+, RJ45 Pin 1)

Glossary

1PPS	Pulse-per-second. Used in hardware timing. A pulse is generated in conjunction with a time stamp. This defines the instant when the time stamp is applicable.
almanac	<p>A file that contains orbit information on all the satellites, clock corrections, and atmospheric delay parameters. The almanac is transmitted by a GPS satellite to a GPS receiver, where it facilitates rapid acquisition of GPS signals when you start collecting data, or when you have lost track of satellites and are trying to regain GPS signals.</p> <p>The orbit information is a subset of the ephemeris / ephemerides data.</p>
AutoBase	AutoBase technology uses the position of the receiver to automatically select the correct base station; allowing for one button press operation of a base station. It shortens setup time associated with repeated daily base station setups at the same location on jobsites.
base station	Also called <i>reference station</i> . A base station in construction, is a receiver placed at a known point on a jobsite that tracks the same satellites as an RTK rover, and provides a real-time differential correction message stream through radio to the rover, to obtain centimeter level positions on a continuous real-time basis. A base station can also be a part of a virtual reference station network, or a location at which GPS observations are collected over a period of time, for subsequent postprocessing to obtain the most accurate position for the location.
BINEX	BIinary EXchange format. BINEX is an operational binary format standard for GPS/GLONASS/SBAS research purposes. It has been designed to grow and allow encapsulation of all (or most) of the information currently allowed for in a range of other formats.
broadcast server	An Internet server that manages authentication and password control for a network of VRS servers, and relays VRS™ corrections from the VRS server that you select.

carrier	A radio wave having at least one characteristic (such as frequency, amplitude, or phase) that can be varied from a known reference value by modulation.
carrier frequency	The frequency of the unmodulated fundamental output of a radio transmitter. The GPS L1 carrier frequency is 1575.42 MHz.
carrier phase	Is the cumulative phase count of the GPS or GLONASS carrier signal at a given time.
cellular modems	A wireless adaptor that connects a laptop computer to a cellular phone system for data transfer. Cellular modems, which contain their own antennas, plug into a PC Card slot or into the USB port of the computer and are available for a variety of wireless data services such as GPRS.
CMR CMR+	Compact Measurement Record. A real-time message format developed by Trimble for broadcasting corrections to other Trimble receivers. CMR is a more efficient alternative to RTCM.
covariance	A statistical measure of the variance of two random variables that are observed or measured in the same mean time period. This measure is equal to the product of the deviations of corresponding values of the two variables from their respective means.
datum	<p>Also called <i>geodetic datum</i>. A mathematical model designed to best fit the geoid, defined by the relationship between an ellipsoid and, a point on the topographic surface, established as the origin of the datum. World geodetic datums are typically defined by the size and shape of an ellipsoid and the relationship between the center of the ellipsoid and the center of the earth. Because the earth is not a perfect ellipsoid, any single datum will provide a better model in some locations than in others. Therefore, various datums have been established to suit particular regions.</p> <p>For example, maps in Europe are often based on the European datum of 1950 (ED-50). Maps in the United States are often based on the North American datum of 1927 (NAD-27) or 1983 (NAD-83).</p> <p>All GPS coordinates are based on the WGS-84 datum surface.</p>
deep discharge	Withdrawal of all electrical energy to the end-point voltage before the cell or battery is recharged.
DGPS	See real-time differential GPS.

differential correction	<p>Differential correction is the process of correcting GPS data collected on a rover with data collected simultaneously at a base station. Because the base station is on a known location, any errors in data collected at the base station can be measured, and the necessary corrections applied to the rover data.</p> <p>Differential correction can be done in real-time, or after the data has been collected by postprocessing.</p>
differential GPS	See real-time differential GPS.
DOP	<p>Dilution of Precision. A measure of the quality of GPS positions, based on the geometry of the satellites used to compute the positions. When satellites are widely spaced relative to each other, the DOP value is lower, and position accuracy is greater. When satellites are close together in the sky, the DOP is higher and GPS positions may contain a greater level of error.</p> <p>PDOP (Position DOP) indicates the three-dimensional geometry of the satellites. Other DOP values include HDOP (Horizontal DOP) and VDOP (Vertical DOP), which indicate the accuracy of horizontal measurements (latitude and longitude) and vertical measurements respectively. PDOP is related to HDOP and VDOP as follows: $PDOP^2 = HDOP^2 + VDOP^2$</p>
dual-frequency GPS	A type of receiver that uses both L1 and L2 signals from GPS satellites. A dual-frequency receiver can compute more precise position fixes over longer distances and under more adverse conditions because it compensates for ionospheric delays.
EGNOS	European Geostationary Navigation Overlay Service. A satellite-based augmentation system (SBAS) that provides a free-to-air differential correction service for GPS. EGNOS is the European equivalent of WAAS, which is available in the United States.
elevation mask	The angle below which the receiver will not track satellites. Normally set to 10 degrees to avoid interference problems caused by buildings and trees, atmospheric issues, and multipath errors.
ellipsoid	An ellipsoid is the three-dimensional shape that is used as the basis for mathematically modeling the earth's surface. The ellipsoid is defined by the lengths of the minor and major axes. The earth's minor axis is the polar axis and the major axis is the equatorial axis.
ephemeris / ephemerides	A list of predicted (accurate) positions or locations of satellites as a function of time. A set of numerical parameters that can be used to determine a satellite's position. Available as broadcast ephemeris or as postprocessed precise ephemeris.

epoch	The measurement interval of a GPS receiver. The epoch varies according to the measurement type: for real-time measurement it is set at one second; for postprocessed measurement it can be set to a rate of between one second and one minute. For example, if data is measured every 15 seconds, loading data using 30-second epochs means loading every alternate measurement.
feature	A feature is a physical object or event that has a location in the real world, which you want to collect position and/or descriptive information (attributes) about. Features can be classified as surface or non-surface features, and again as points, lines/breaklines, or boundaries/areas.
firmware	The program inside the receiver that controls receiver operations and hardware.
GLONASS	Global Orbiting Navigation Satellite System. GLONASS is a Soviet space-based navigation system comparable to the American GPS system. The operational system consists of 21 operational and 3 non-operational satellites in 3 orbit planes.
GNSS	Global Navigation Satellite System.
GSOF	General Serial Output Format. A Trimble proprietary message format.
HDOP	Horizontal Dilution of Precision. HDOP is a DOP value that indicates the accuracy of horizontal measurements. Other DOP values include VDOP (vertical DOP) and PDOP (Position DOP). Using a maximum HDOP is ideal for situations where vertical precision is not particularly important, and your position yield would be decreased by the vertical component of the PDOP (for example, if you are collecting data under canopy).
L1	The primary L-band carrier used by GPS and GLONASS satellites to transmit satellite data.
L2	The secondary L-band carrier used by GPS and GLONASS satellites to transmit satellite data.
L2C	A modernized code that allows significantly better ability to track the L2 frequency.
L5	The third L-band carrier used by GPS satellites to transmit satellite data. L5 will provide a higher power level than the other carriers. As a result, acquiring and tracking weak signals will be easier.

Moving Base	Moving Base is an RTK positioning technique in which both reference and rover receivers are mobile. Corrections are sent from a “base” receiver to a “rover” receiver and the resultant baseline (vector) has centimeter-level accuracy.
MSAS	MTSAT Satellite-Based Augmentation System. A satellite-based augmentation system (SBAS) that provides a free-to-air differential correction service for GPS. MSAS is the Japanese equivalent of WAAS, which is available in the United States.
multipath	Interference, similar to ghosts on an analog television screen, that occurs when GPS signals arrive at an antenna having traversed different paths. The signal traversing the longer path yields a larger pseudorange estimate and increases the error. Multiple paths can arise from reflections off the ground or off structures near the antenna.
NMEA	National Marine Electronics Association. NMEA 0183 defines the standard for interfacing marine electronic navigational devices. This standard defines a number of ‘strings’ referred to as NMEA strings that contain navigational details such as positions. Most Trimble GPS receivers can output positions as NMEA strings.
OmniSTAR	The OmniSTAR HP/XP service allows the use of new generation dual-frequency receivers with the OmniSTAR service. The HP/XP service does not rely on local reference stations for its signal, but utilizes a global satellite monitoring network. Additionally, while most current dual-frequency GPS systems are accurate to within a meter or so, OmniSTAR with XP is accurate in 3D to better than 30 cm.
PDOP	Position Dilution of Precision. PDOP is a DOP value that indicates the accuracy of three-dimensional measurements. Other DOP values include VDOP (vertical DOP) and HDOP (Horizontal Dilution of Precision). Using a maximum PDOP value is ideal for situations where both vertical and horizontal precision are important.
postprocessing	Postprocessing is the processing of satellite data after it has been collected, in order to eliminate error. This involves using computer software to compare data from the rover with data collected at the base station.

real-time differential GPS	<p>Also known as <i>real-time differential correction</i> or <i>DGPS</i>. Real-time differential GPS is the process of correcting GPS data as you collect it. Corrections are calculated at a base station and then sent to the receiver through a radio link. As the rover receives the position it applies the corrections to give you a very accurate position in the field.</p> <p>Most real-time differential correction methods apply corrections to code phase positions.</p> <p>While DGPS is a generic term, its common interpretation is that it entails the use of single-frequency code phase data sent from a GPS base station to a rover GPS receiver to provide sub-meter position accuracy. The rover receiver can be at a long range (greater than 100 kms (62 miles)) from the base station.</p>
rover	<p>A rover is any mobile GPS receiver that is used to collect or update data in the field, typically at an unknown location.</p>
Roving mode	<p>Roving mode applies to the use of a rover receiver to collect data, stakeout, or control earthmoving machinery in real time using RTK techniques.</p>
RTCM	<p>Radio Technical Commission for Maritime Services. A commission established to define a differential data link for the real-time differential correction of roving GPS receivers. There are three versions of RTCM correction messages. All Trimble GPS receivers use Version 2 protocol for single-frequency DGPS type corrections. Carrier phase corrections are available on Version 2, or on the newer Version 3 RTCM protocol, which is available on certain Trimble dual-frequency receivers. The Version 3 RTCM protocol is more compact but is not as widely supported as Version 2.</p>
RTK	<p>real-time kinematic. A real-time differential GPS method that uses carrier phase measurements for greater accuracy.</p>
SBAS	<p>Satellite-Based Augmentation System. SBAS is based on differential GPS, but applies to wide area (WAAS/EGNOS and MSAS) networks of reference stations. Corrections and additional information are broadcast via geostationary satellites.</p>
signal-to-noise ratio	<p>SNR. The signal strength of a satellite is a measure of the information content of the signal, relative to the signal's noise. The typical SNR of a satellite at 30° elevation is between 47 and 50 dBHz.</p>
skyplot	<p>The satellite skyplot confirms reception of a differentially corrected GPS signal and displays the number of satellites tracked by the GPS receiver, as well as their relative positions.</p>

SNR	See signal-to-noise ratio.
triple frequency GPS	A type of receiver that uses three carrier phase measurements (L1, L2, and L5).
UTC	Universal Time Coordinated. A time standard based on local solar mean time at the Greenwich meridian.
VRS	<p>Virtual Reference Station. A VRS system consists of GPS hardware, software, and communication links. It uses data from a network of base stations to provide corrections to each rover that are more accurate than corrections from a single base station.</p> <p>To start using VRS corrections, the rover sends its position to the VRS server. The VRS server uses the base station data to model systematic errors (such as ionospheric noise) at the rover position. It then sends RTCM correction messages back to the rover.</p>
WAAS	<p>Wide Area Augmentation System. WAAS was established by the Federal Aviation Administration (FAA) for flight and approach navigation for civil aviation. WAAS improves the accuracy and availability of the basic GPS signals over its coverage area, which includes the continental United States and outlying parts of Canada and Mexico.</p> <p>The WAAS system provides correction data for visible satellites. Corrections are computed from ground station observations and then uploaded to two geostationary satellites. This data is then broadcast on the L1 frequency, and is tracked using a channel on the GPS receiver, exactly like a GPS satellite.</p> <p>Use WAAS when other correction sources are unavailable, to obtain greater accuracy than autonomous positions. For more information on WAAS, refer to the FAA website at http://gps.faa.gov.</p> <p>The EGNOS service is the European equivalent and MSAS is the Japanese equivalent of WAAS.</p>
WGS-84	<p>World Geodetic System 1984. Since January 1987, WGS-84 has superseded WGS-72 as the datum used by GPS.</p> <p>The WGS-84 datum is based on the ellipsoid of the same name.</p>



www.trimble.com